



DENTAL INSTRUMENTS



# Contents

<b>S.No</b>	<b>Descriptions</b>	<b>Page No</b>
1	Extracting Forceps - English Pattern	03
2	Root Elevators	32
3	Filling Instruments	56
4	Periodontal Curettes and Filling Instruments	67
5	Dental Probes	71
6	Burnishers and Pocket Probes Scalars	72
7	Periodontal Instruments	75
8	Periodontia Instruments and Mallets	82
9	Gracey Curettes	83
10	Curettes and Scalars	87
11	Bone Curettes	89
12	Modelling Instruments	91
13	Measuring Instruments	92
14	Wax Knives	94
15	Plaster Knives	95
16	Diagnostic	96
17	Endodontic Instruments	97
18	Excavators	102
19	Handles for Mouth Mirrors and Mouth Mirrors	104
20	Cement Spatulas	106
21	Spatulas for Plaster and Alginate	108
22	Needle Holders	110
23	Needle Holders & Stainless Steel Saliva Ejectors	115
24	Water Syringes	116
25	Syringes, Rulers, Band Adaptor, Position Gauge	117
26	Dental Syringes	122
27	Intra-Ligamental Syringes & Dental Syringes	125
28	Dental Tweezers And Gum Scissor	126
29	Rubber Dam Clamp Forceps	138
30	Matrix Retainers and Matrix Bands	144
31	Dental Crown Removers, Scissors, Forceps, Amalgum Guns & Carriers	147
32	Amalgum Guns and Carriers	148
33	Copper Ring Removing Pliers, Paper Articulator Forceps	149
34	Rongeurs	150
35	Bone Elevators	154
36	Bone Files and Chisels	155
37	Pliers for Orthodontics	156
38	Stainless Steel Impression Trays	183
39	Articulators	187
40	Hollowware's	189

# Company Profile



**LAHEEF ENTERPRISES** is a leading manufacturer and supplier of all kinds of Dental Instruments, Orthodontic tools, Implants, Scissors and wide range of Orthodontic Pliers & Cutters to worldwide. All of our instruments are ISO 9001:2008, ISO 13485:2012 and CE mark certified in accordance with the Medical Devices Directive. We also provide OEM services and customized packaging to our valuable customers. We offer special discounted prices for our distributors.

Having our manufacturing unit in Sialkot (Pakistan), world's renowned city for the manufacturing of Dental & Surgical Instruments. We worked hard to build our reputation in this evolving industry and our satisfied customers are our strength. Our products are manufactured using the best quality stainless steel as AISI, ASTM and DIN standard's recommended which is imported from Germany, Japan and France. The key to our success is our quality assurance. We use the right material for the right products.

**Health and Safety Policy, Environment Policy** always adopted as per international standard.

## **Quality Policy:-**

- Improved Quality
- Cost Reductions
- Working for Customer satisfaction
- Customized products for special needs customers
- Package designing and innovation
- New products or existing product enhancements

**Laheef Enterprises** prices are very competitive and very flexible with customers provide maximum co-operation. We aim to provide excellent customer service and we promote a 'can do' culture. We aspire to being the easiest company in the market to deal with for any and all of your surgical instrument's needs.

**Our customers** are our most important asset and **Laheef** endeavors to provide a personalized customer service experience. We aim to provide the highest level of customer service to the International Healthcare market and are proud that we have built and continue to maintain solid relationships with our customers and distributors.

At all times we are professional, honest, ethical and reliable.

Thanks and Best Regards

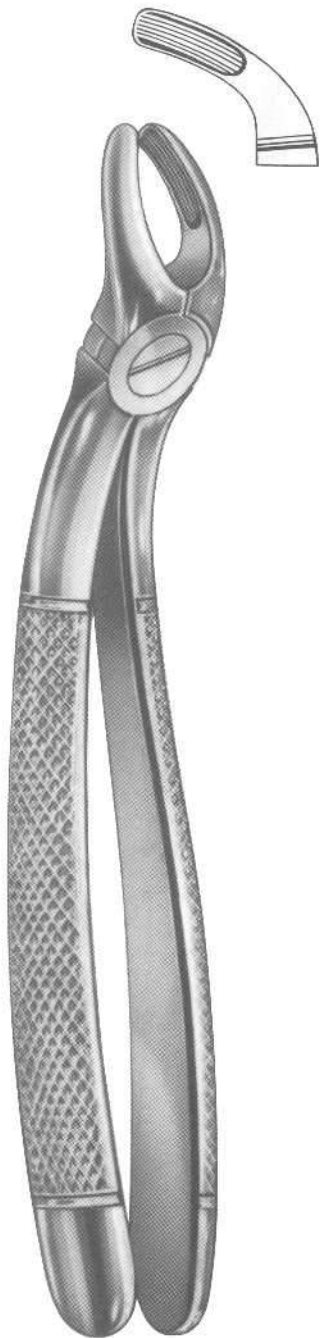

**LE-1006**  
Fig 19  
upper wisdoms

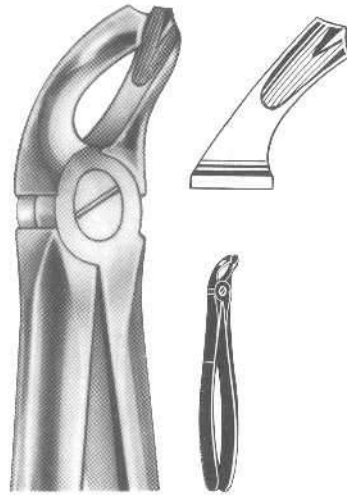

**LE-1007**  
Fig 20  
lower wisdoms

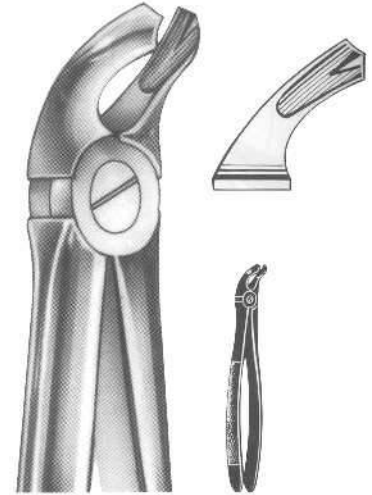

**LE-1008**  
Fig 21  
lower molars

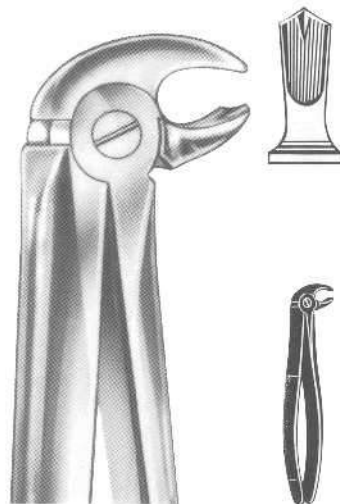

**LE-1009**  
Fig 22  
lower molars

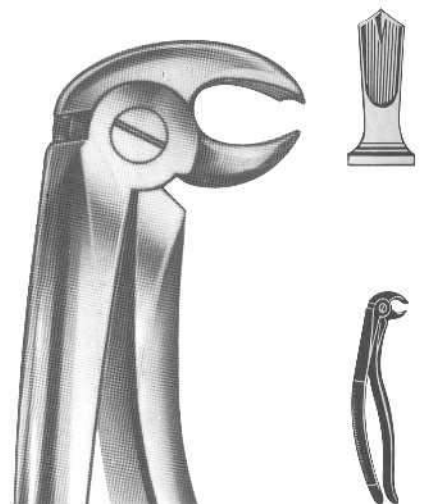

**LE-1010**  
Fig 22 A  
Albrecht  
lower molars



**LE-1001**  
Fig 8  
lower premolars

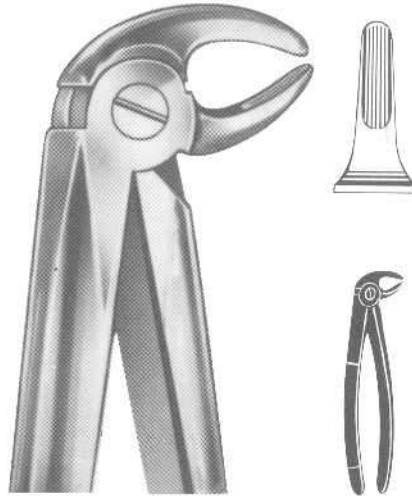

**LE-1002**  
Fig 13  
lower premolars

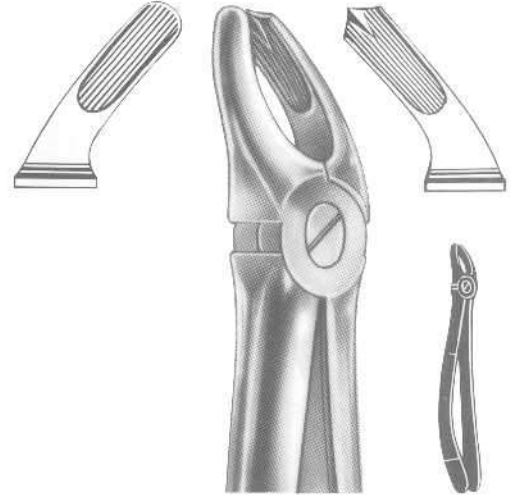

**LE-1003**  
Fig 17  
upper molars, right

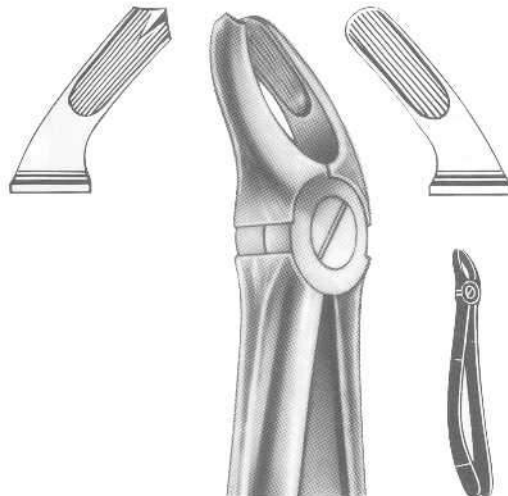

**LE-1004**  
Fig 18  
upper molars, left

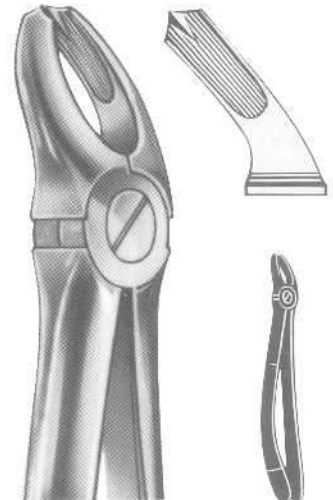

**LE-1005**  
Fig 18 A  
upper molars

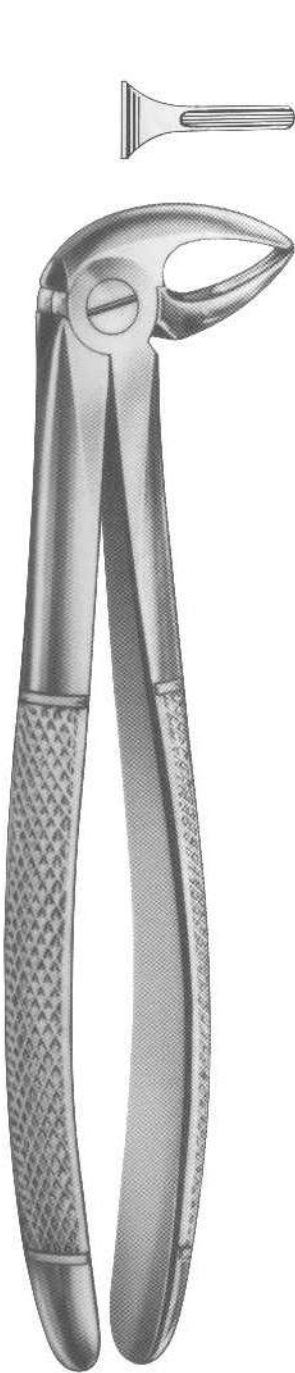

**LE-1011**  
Fig 33 A  
lower roots

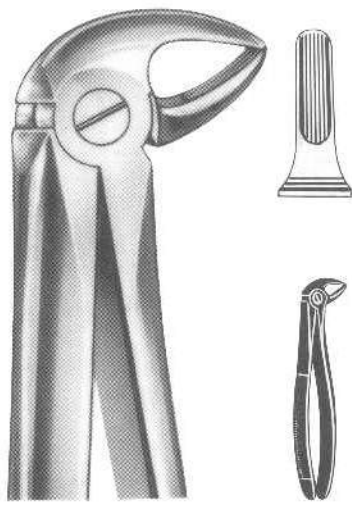

**LE-1012**  
Fig 33 B  
lower roots

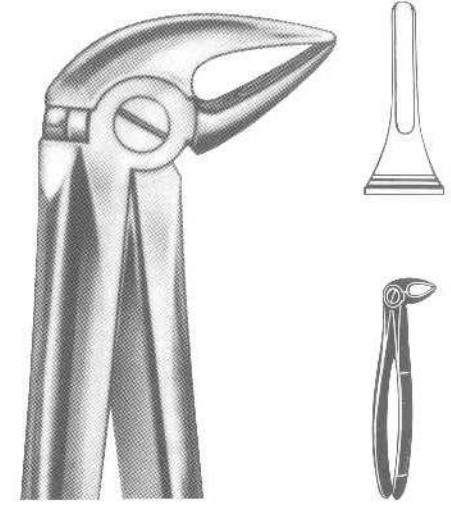

**LE-1013**  
Fig 33 L  
lower roots

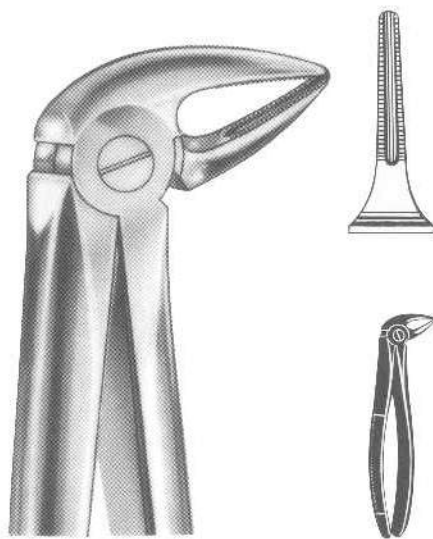

**LE-1014**  
Fig 33 L  
lower roots



**LE-1015**  
Fig 33 S  
lower roots, for children

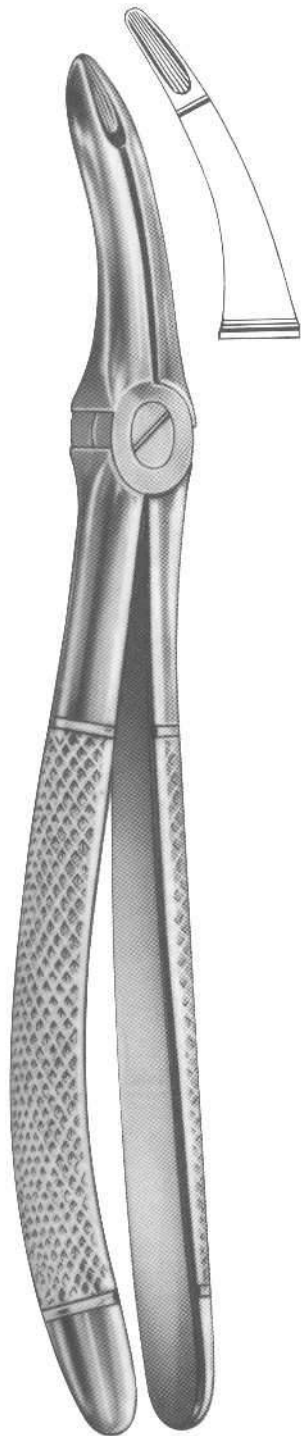

**LE-1016**  
Fig 44  
upper roots

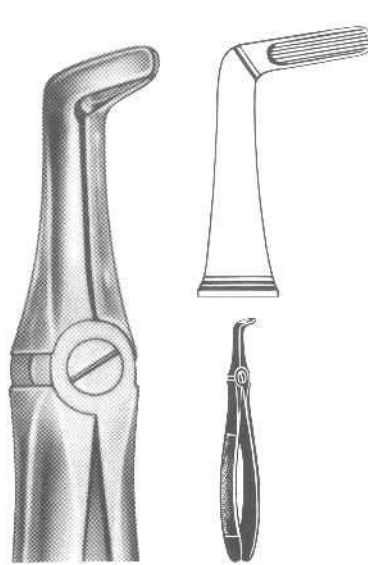

**LE-1017**  
Fig 45  
lower roots

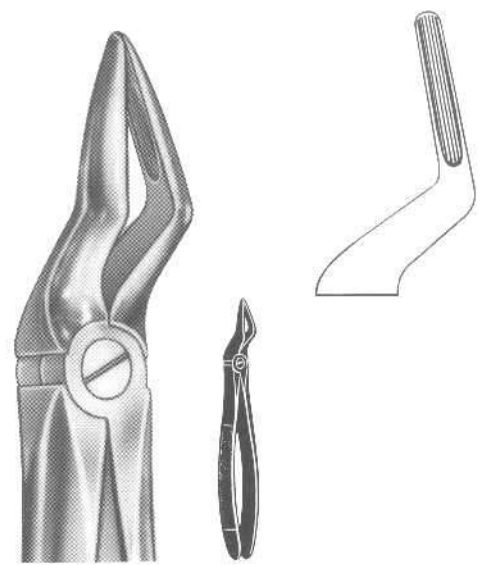

**LE-1018**  
Fig 12  
upper roots

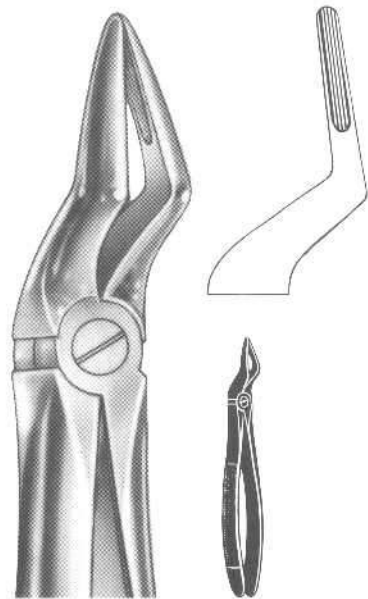

**LE-1019**  
Fig 51 A  
upper roots

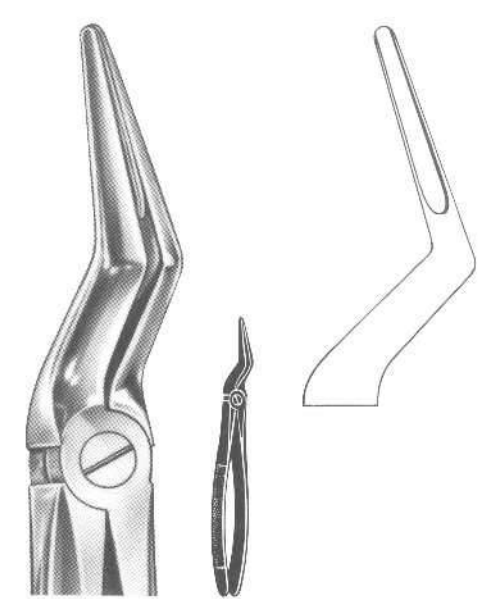

**LE-1020**  
Fig 51 L  
upper roots

# "Relax" - Extracting Forceps



**Relax**  
**LE-1021**  
Fig 51  
upper roots

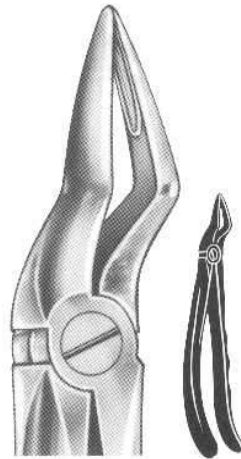

**Relax**  
**LE-1022**  
Fig 51 A  
upper roots

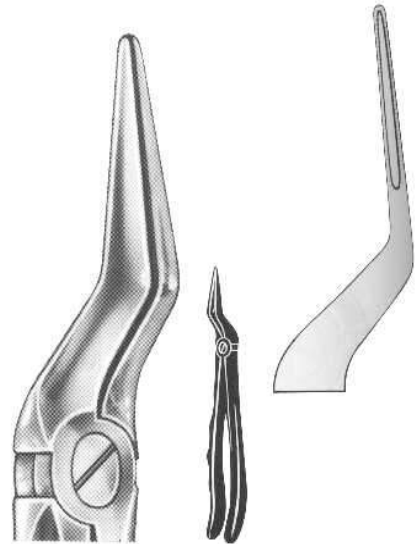
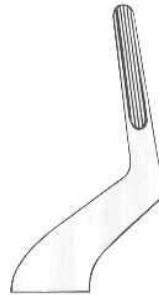

**Relax**  
**LE-1023**  
Fig 51 L  
upper roots



**Relax**  
**LE-1024**  
Fig 67  
upper wisdoms

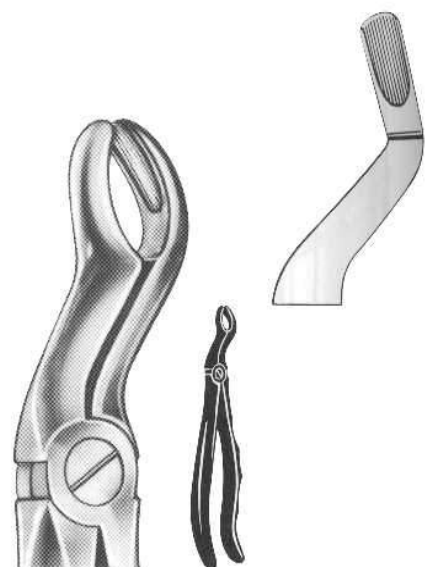
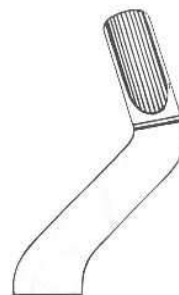

**Relax**  
**LE-1025**  
Fig 67 A  
upper wisdoms





**1026**  
 Fig 37  
 Upper incisors



**1027**  
 Fig 39  
 Upper molars

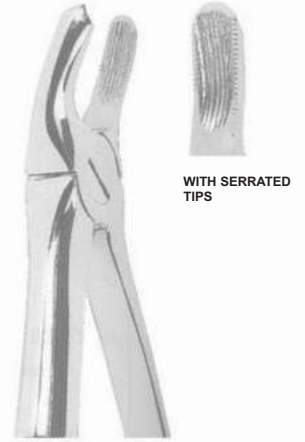

**1028**  
 Fig 39 R  
 Upper molars, right

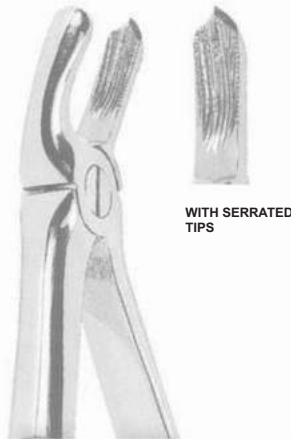

**1029**  
 Fig 39 L  
 Upper molars, left



**1030**  
 Fig 515  
 Upper roots

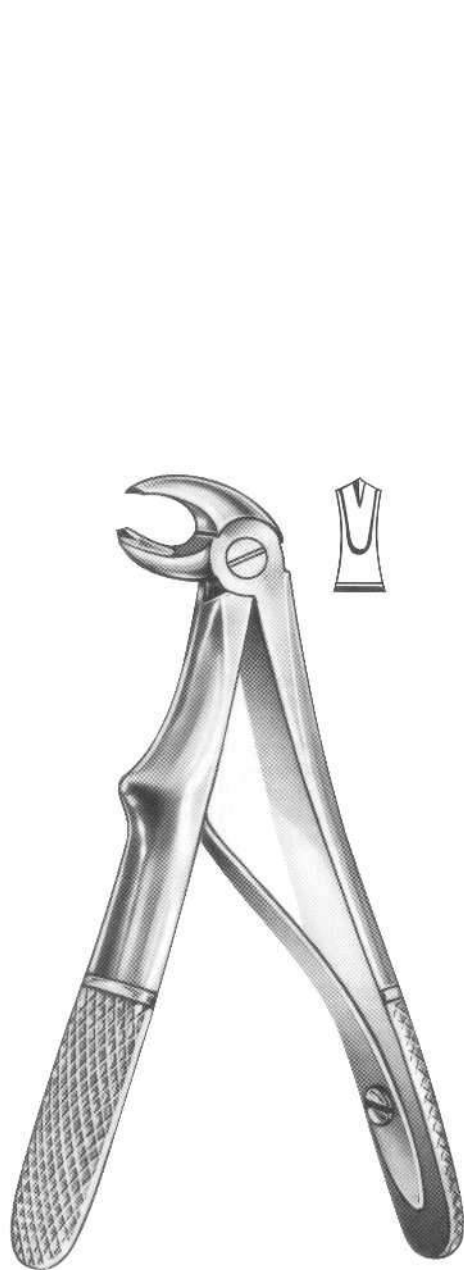

**Klein**  
**LE-1031**  
Fig 6  
lower molars

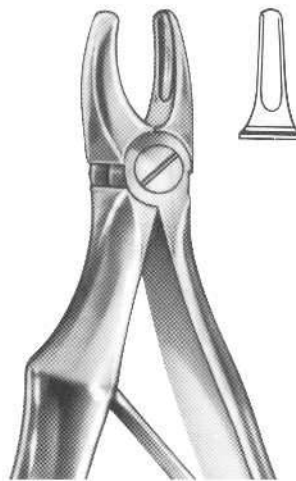

**Klein**  
**LE-1032**  
Fig 137  
upper incisors



**Klein**  
**LE-1033**  
Fig 5  
lower incisors

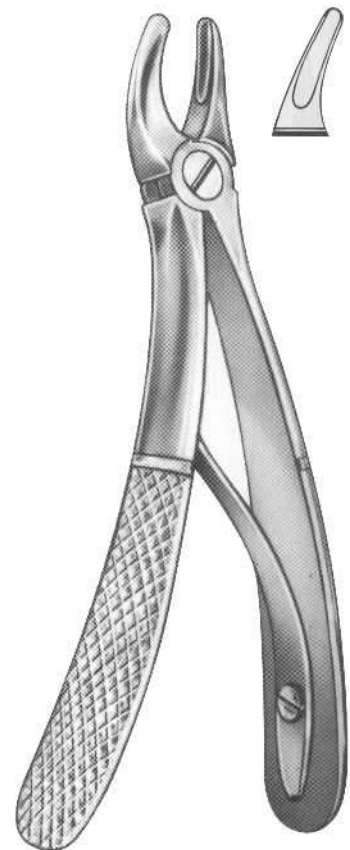

**Klein**  
**LE-1034**  
Fig 139  
uper premolars



WITH SERRATED TIPS

**LE-1035**  
Fig 43 A  
Fractured or decayed upper teeth

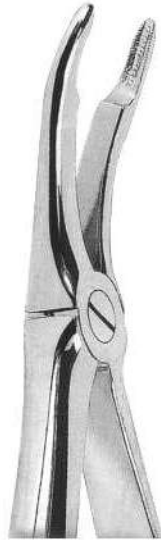

WITH SERRATED TIPS

**LE-1036**  
Fig 44  
Upper roots



WITH SERRATED TIPS

**LE-1037**  
Fig 45  
Lower roots

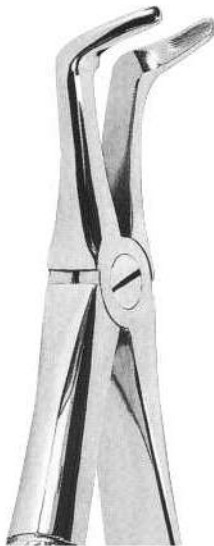

WITH SERRATED TIPS

**LE-1038**  
Fig 46  
Lower roots



WITH SERRATED TIPS

**LE-1039**  
Fig 46 L  
Lower roots



**LE-1050**  
Fig 59  
Lower roots

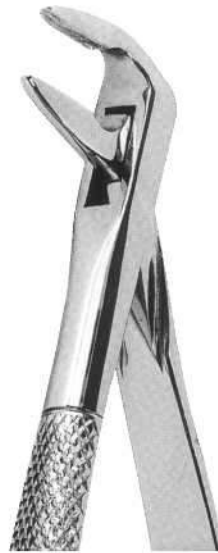

**LE-1051**  
Fig 59 L  
Lower incisor roots

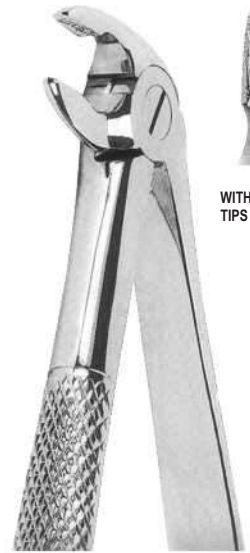

**LE-1052**  
Fig 60  
Lower roots

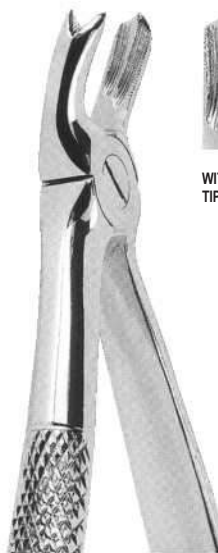

**LE-1053**  
Fig 65 L  
Upper molars, left



**LE-1054**  
Fig 65 R  
Upper molars, right





**LE-1055**  
Fig 66 L  
Upper molars, left

WITH SERRATED  
TIPS

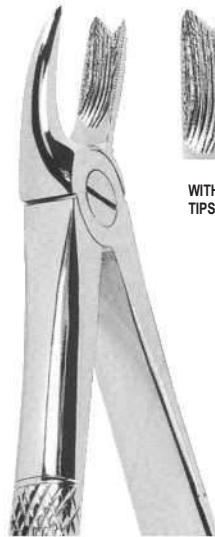

**LE-1056**  
Fig 66 R  
Upper molars, right

WITH SERRATED  
TIPS



**LE-1057**  
Fig 67  
Upper three molars

WITH SERRATED  
TIPS



**LE-1058**  
Fig 67 A  
Upper third molars

WITH SERRATED  
TIPS



**LE-1059**  
Fig 68  
Lower roots

WITH SERRATED  
TIPS



**LE-1060**  
Fig 67½ L  
Upper third molars, left



WITH SERRATED TIPS



**LE-1061**  
Fig 67½ R  
Upper third molars, right



WITH SERRATED TIPS



**LE-1062**  
Fig 73  
Lower molars



WITH SERRATED TIPS

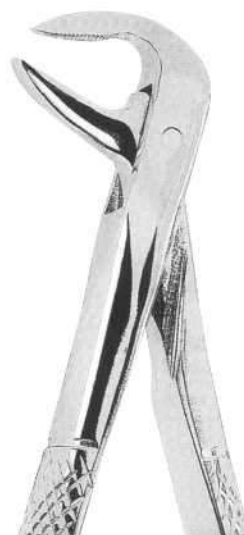

**LE-1063**  
Fig 74  
Lower roots



WITH SERRATED TIPS

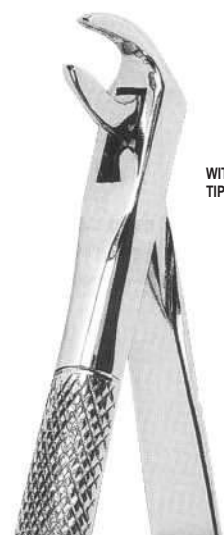

**LE-1064**  
Fig 74 M  
Lower roots



WITH SERRATED TIPS



**LE-1065**  
Fig 74 N  
Lower roots



WITH SERRATED  
TIPS

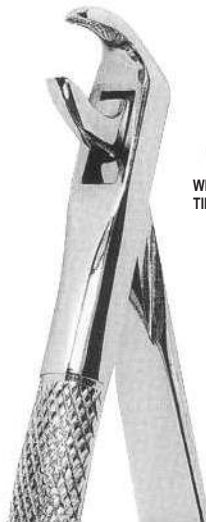

**LE-1066**  
Fig 75  
Lower canines and  
premolars



WITH SERRATED  
TIPS



**LE-1067**  
Fig 79  
Lower third molars



WITH SERRATED  
TIPS



**LE-1068**  
Fig 79 A  
Lower third molars



WITH SERRATED  
TIPS



**LE-1069**  
Fig 79 C  
Lower third molars



WITH SERRATED  
TIPS

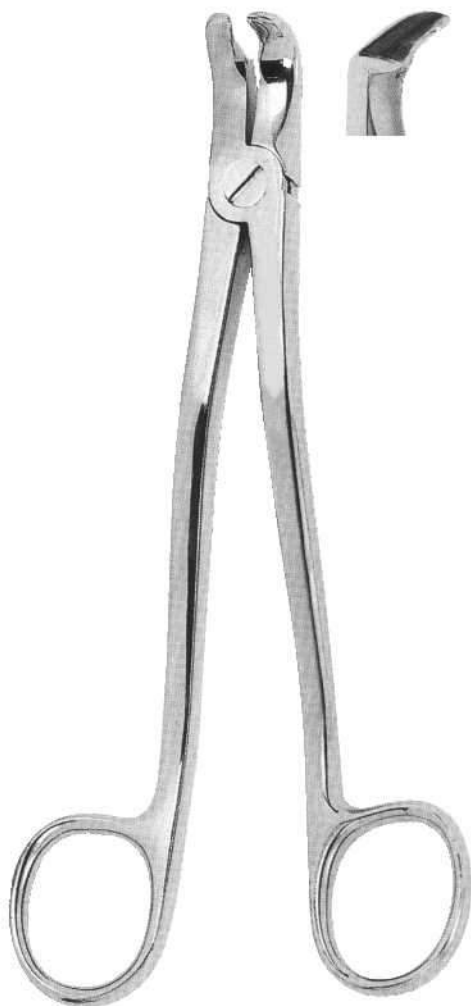

**LE-1070**  
Fig 86 W  
Lower third molars



**LE-1071**  
Fig 86½ L  
Lower third molars, left



**LE-1072**  
Fig 86½ R  
Lower third molars, right

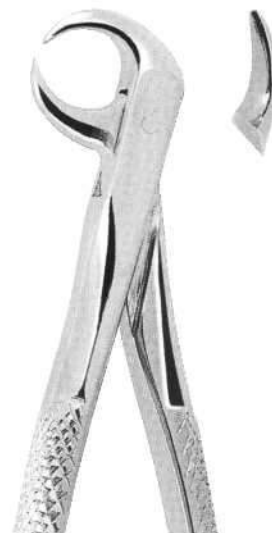

**LE-1073**  
Fig 86 C  
Lower molars





**LE-1074**  
Fig 87  
Lower decayed molars  
or broken-down crowns



WITH SERRATED  
TIPS

**LE-1075**  
Fig 89  
Upper molars, right



WITH SERRATED  
TIPS

**LE-1076**  
Fig 90  
Upper molars, left

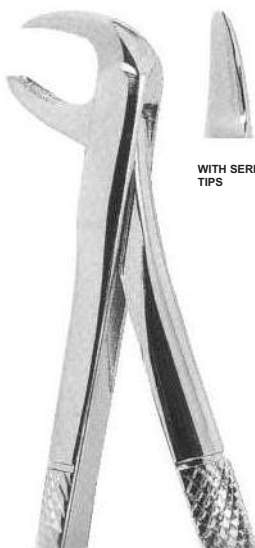

WITH SERRATED  
TIPS

**LE-1077**  
Fig 99  
Broken-down lower molars

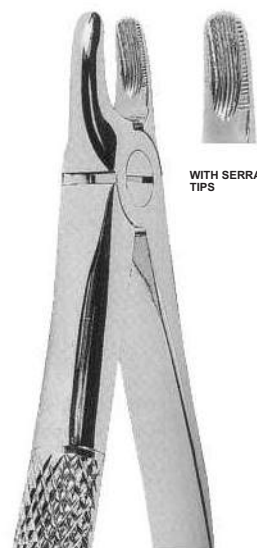

WITH SERRATED  
TIPS

**LE-1078**  
Fig 107  
Upper canines



WITH SERRATED TIPS

**LE-1079**  
Fig 121  
Upper third molars

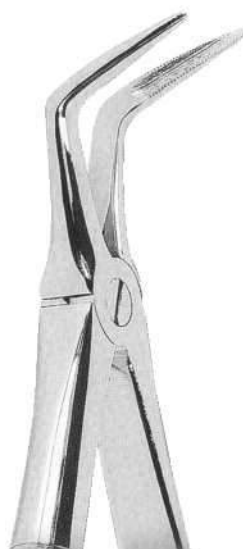

WITH SERRATED TIPS

**LE-1080**  
Fig 145  
Lower roots

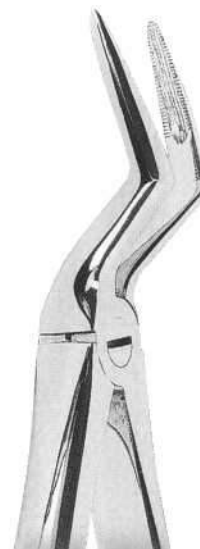

WITH SERRATED TIPS

**LE-1081**  
Fig 151½  
Upper roots



WITH SERRATED TIPS

**LE-1082**  
Fig 166  
Universal extracting forceps for upper teeth, in particular molars and premolars

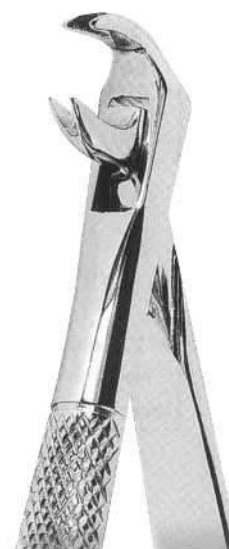

WITH SERRATED TIPS

**LE-1083**  
Fig 167  
Universal extracting forceps for lower teeth, in particular molars and premolars



**LE-1084**  
Fig 168  
Upper canines

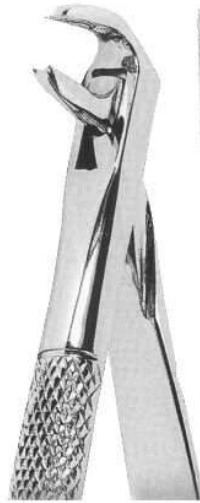

**LE-1085**  
Fig 169  
Lower canines

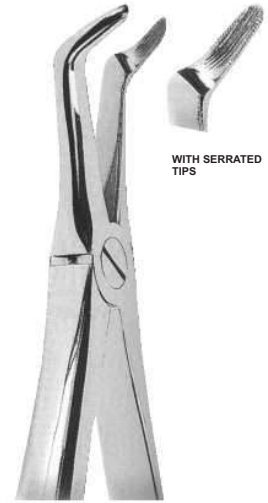

**LE-1086**  
Fig 346  
Lower roots



**LE-1087**  
Fig 349  
Upper roots

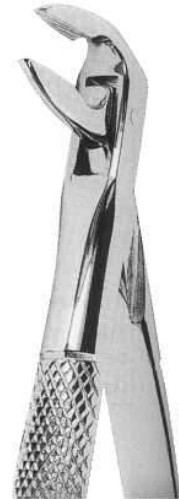

**LE-1088**  
Fig 359  
Lower roots





**LE-1089**  
Fig 1  
Universal extracting forcep for upper incisors and canines

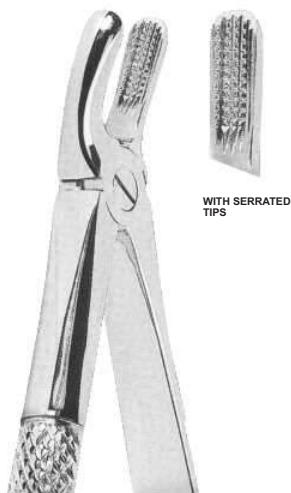

**LE-1090**  
Fig 2  
Upper molars



**LE-1091**  
Fig 3  
Lower incisors, premolar and roots



**LE-1092**  
Fig 4  
Lower molars

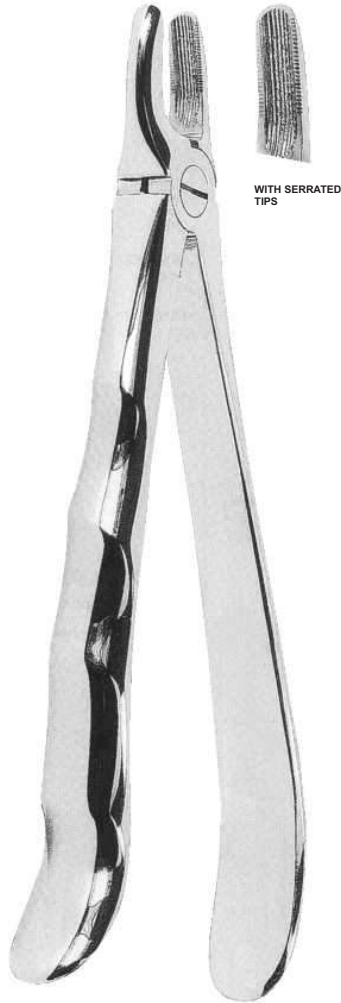

**LE-1093**  
Fig 1  
Upper incisors  
and canines

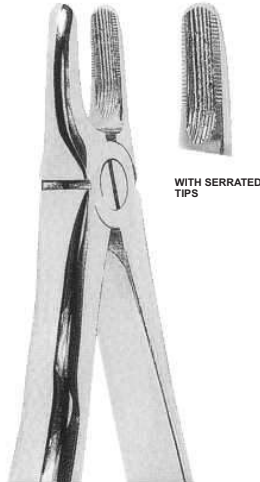

**LE-1094**  
Fig 2  
Upper incisors  
and canines

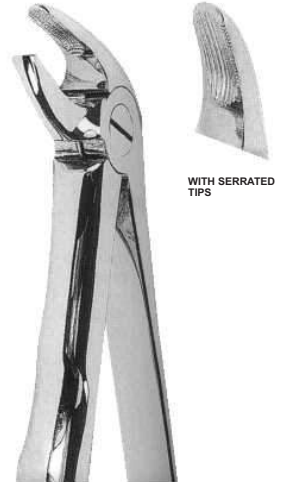

**LE-1095**  
Fig 4  
Lower incisors  
and canines

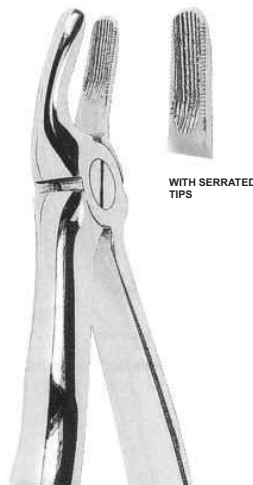

**LE-1096**  
Fig 7  
Upper premolars



**LE-1097**  
Fig 13  
Lower premolars

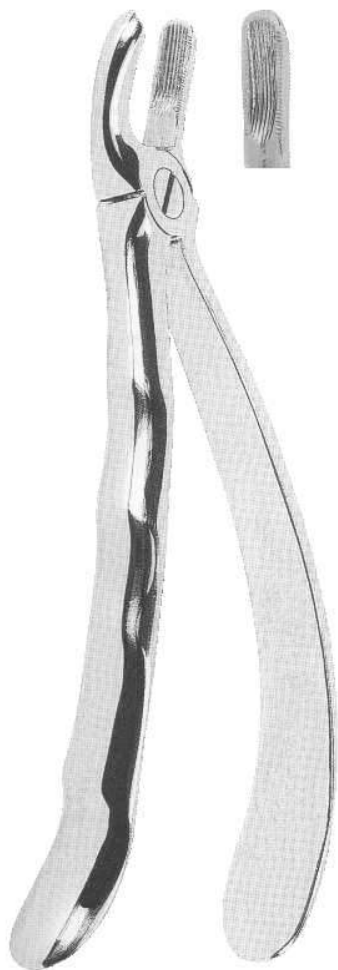

**LE-1098**  
Fig 17  
Upper molars, right

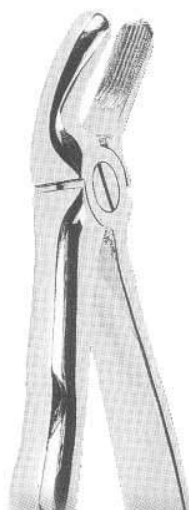

WITH SERRATED TIPS

**LE-1099**  
Fig 18  
Upper molars, left

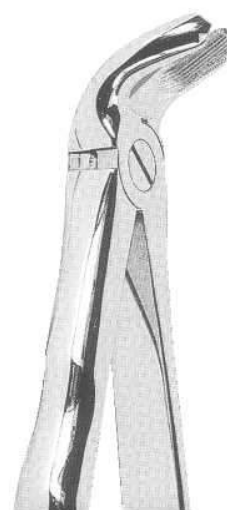

WITH SERRATED TIPS

**LE-1100**  
Fig 21  
Lower molars

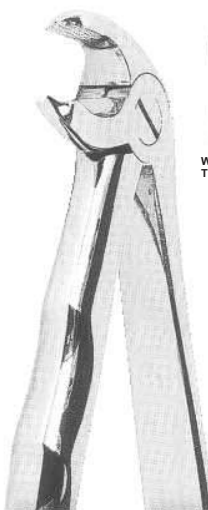

WITH SERRATED TIPS

**LE-1101**  
Fig 22  
Lower molars

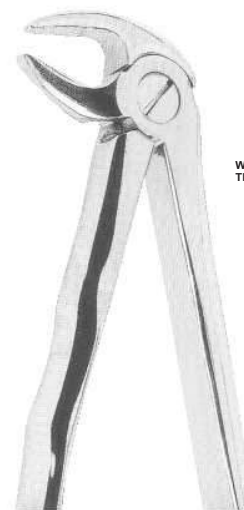

WITH SERRATED TIPS

**LE-1102**  
Fig 33  
Lower roots



**LE-1110**  
Fig 89  
Upper molars, right

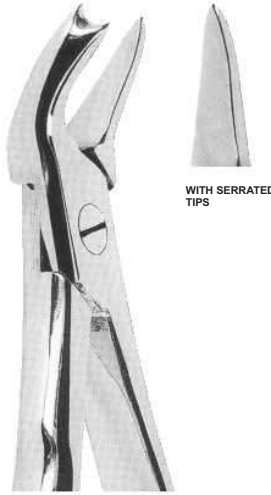

**LE-1111**  
Fig 90  
Upper molars, left

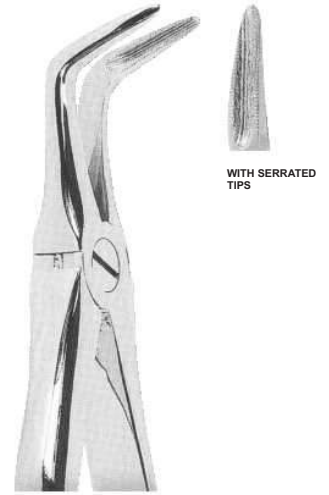

**LE-1112**  
Fig 145  
Lower roots

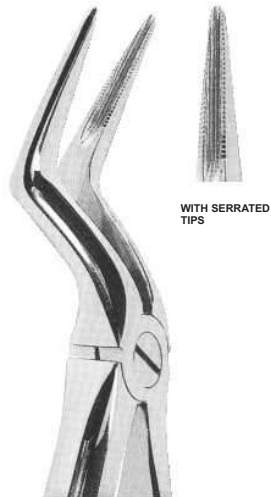

**LE-1113**  
Fig 151 ½  
Upper roots

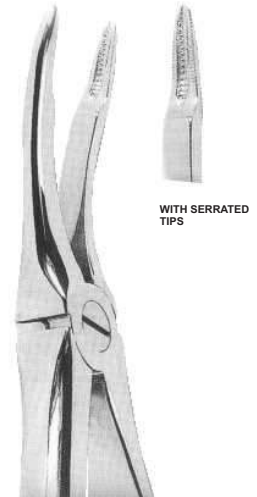

**LE-1114**  
Fig 349  
Upper roots

# Extracting Forceps With Anatomically Shaped Handle

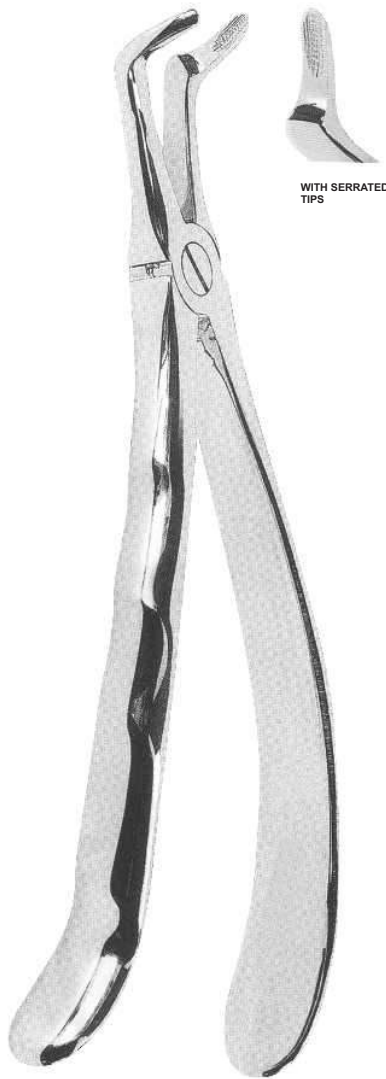

**LE-1103**  
Fig 45  
Lower roots



WITH SERRATED TIPS



**LE-1104**  
Fig 51 A  
Upper roots



WITH SERRATED TIPS



**LE-1105**  
Fig 67 A  
Upper third molars



WITH SERRATED TIPS



**LE-1106**  
Fig 74  
Lower roots



WITH SERRATED TIPS



**LE-1107**  
Fig 79  
Lower third molars



WITH SERRATED TIPS



**LE-1108**  
Fig 86 C  
Lower molars



WITH SERRATED TIPS



**LE-1109**  
Fig 359  
Lower roots



WITH SERRATED TIPS





**LE-1115**  
 Fig 5  
 Lower third molars



**LE-1116**  
 Fig 6  
 Separating forcep



**LE-1117**  
 Fig 105  
 Upper molars



**LE-1118**  
 Fig 16  
 Lower molars



**LE-1119**  
 Fig 17  
 Lower molars



**LE-1120**  
Fig 18 L  
Upper molars, left

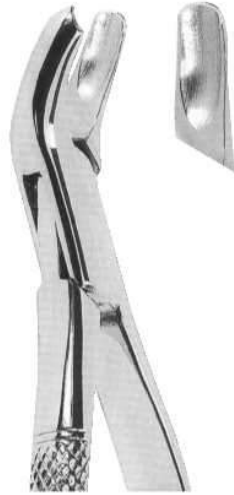

**LE-1121**  
Fig 18 R  
Upper molars, right



**LE-1122**  
Fig 23  
Lower molars



**LE-1123**  
Fig 53 R  
Upper molars, right



**LE-1124**  
Fig 53 L  
Upper molars, left



**LE-1125**  
 Fig 65  
 Upper incisors and roots

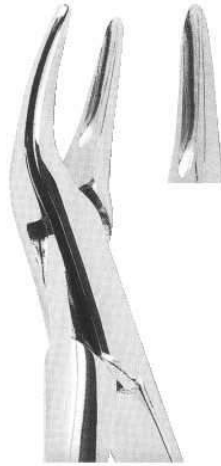

**LE-1126**  
 Fig 69  
 Upper and lower roots



**LE-1127**  
 Fig 88 R  
 Upper molars, right



**LE-1128**  
 Fig 88 L  
 Upper molars, left

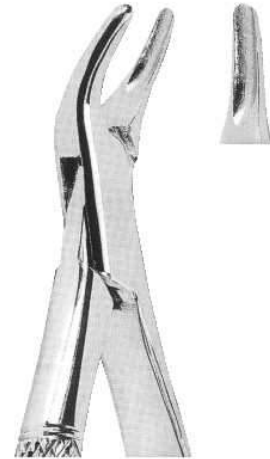

**LE-1129**  
 Fig 101  
 Deciduous teeth



**LE-1130**  
Fig 150  
Upper incisors, premolars, roots



**LE-1131**  
Fig 150 S  
Upper teeth (for children)



**LE-1132**  
Fig 151  
Upper incisors, premolars, roots

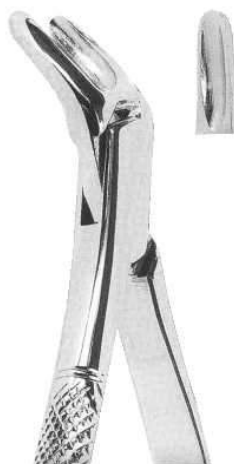

**LE-1133**  
Fig 151S  
Lower teeth (for children)

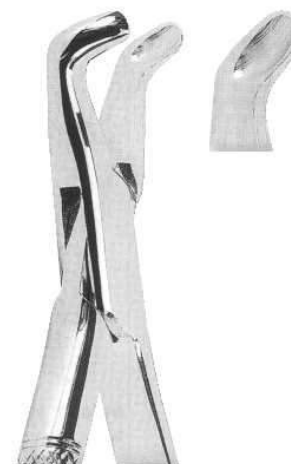

**LE-1134**  
Fig 222  
Lower third molars



**LE-1135**  
Fig 1  
upper incisors and bicuspid

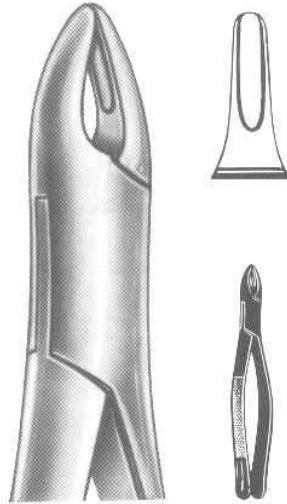

**LE-1136**  
Fig 1 B  
upper roots, anterior

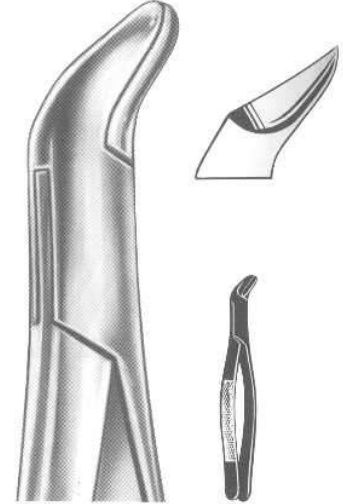

**Physick**  
**LE-1137**  
Fig 5  
lower wisdoms

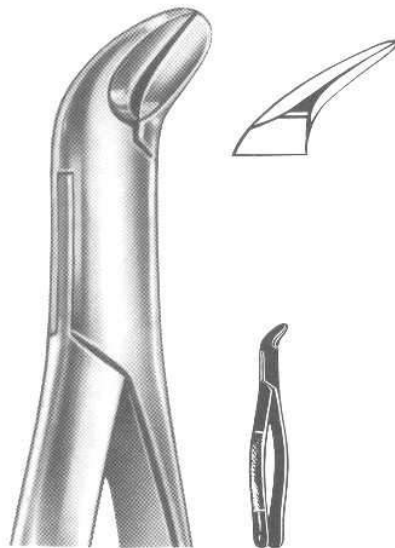

**LE-1138**  
Fig 6  
lower molars, splitting forceps

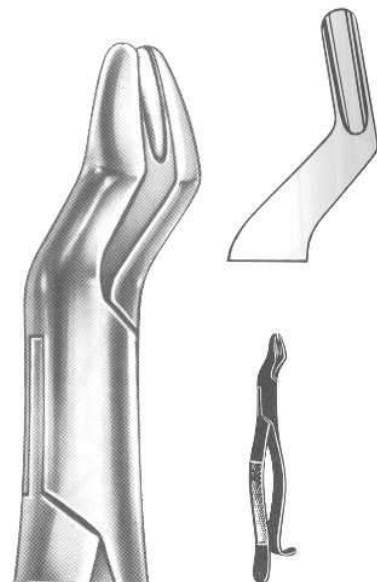

**LE-1139**  
Fig 10 H  
upper molars



WITH SERRATED  
TIPS

**LE-1140**  
Fig 135  
Lower premolars



**LE-1141**  
Fig 225  
Lower molars



**LE-1142**  
Fig 305  
Upper incisors  
and roots



WITH SERRATED  
TIPS

**LE-1143**  
Fig 33 S  
Lower roots



WITH SERRATED  
TIPS

**LE-1144**  
Fig 38  
Lower incisors  
and canines

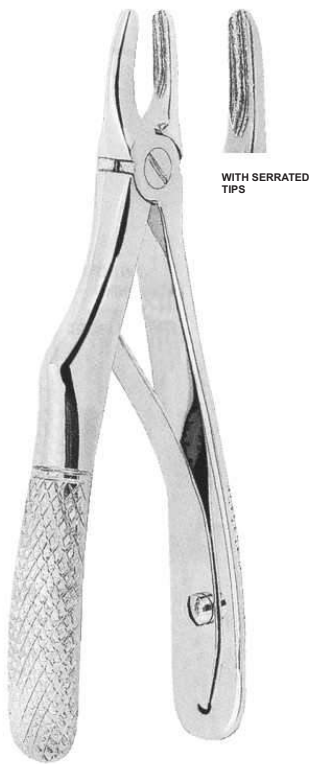

**LE-1145**  
Fig 1  
Upper incisors



**LE-1146**  
Fig 2  
Upper premolars



**LE-1147**  
Fig 3  
Upper molars



**LE-1148**  
Fig 4  
Upper roots



**LE-1149**  
Fig 5  
Lower incisors

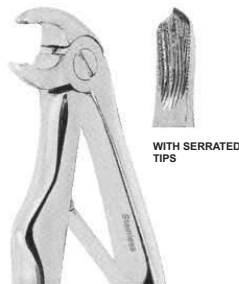

**LE-1150**  
Fig 6  
Lower molars



**LE-1151**  
Fig 7  
Lower roots



**LE-1152**  
Fig 1  
Lower roots



**LE-1153**  
Fig 2  
Upper roots



**LE-1155**  
Fig 2  
Roots fragments



**LE-1154**  
Fig 1  
Roots fragments



lower jaw, left side



LE-1200

lower jaw, right side



LE-1201

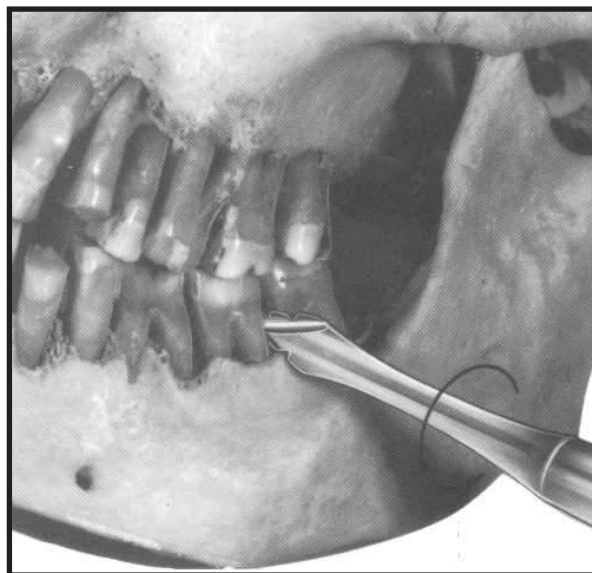

Root elevator, spiral-shaped, for extremely facilitated extraction of the molars in the lower jaw. The slender, conical points allow deep penetration between tooth and gum. Owing to the hook-shaped working parts, slipping of the elevator is avoided.

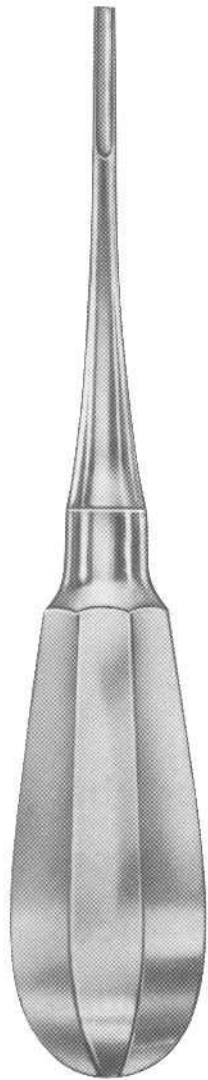

Bein

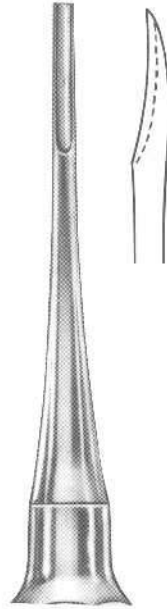

**Bein**  
**LE-1202**  
Fig 1

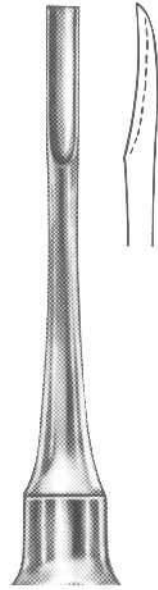

**Bein**  
**LE-1203**  
Fig 2

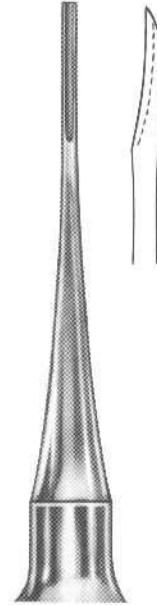

**Bein**  
**LE-1204**  
Fig 0



**Bein**  
**LE-1205**  
Fig 3

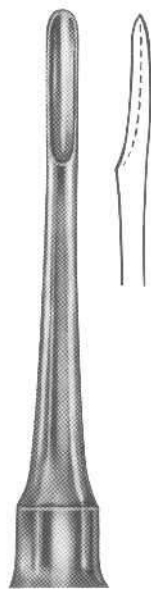

**Bein**  
**LE-1206**  
Fig 4



**Bein**  
**LE-1207**  
Fig 5

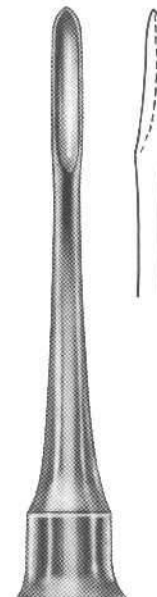

**Bein**  
**LE-1208**  
Fig 6

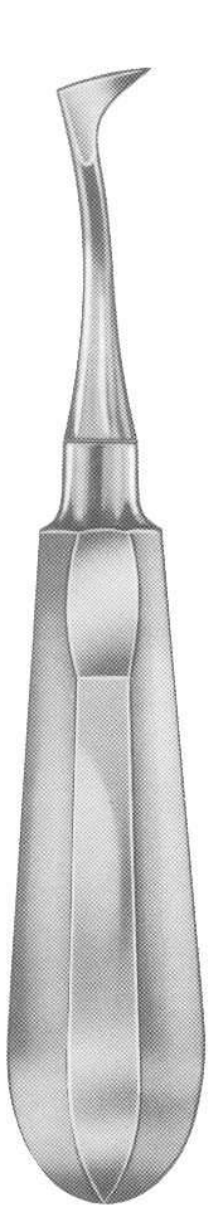

**Seldin**



**Seldin  
LE-1209  
Fig 1L**



**Seldin  
LE-1210  
Fig 1R**



**Seldin  
LE-1211  
Fig 2**



**Seldin  
LE-1212  
Fig 3**



**Seldin  
LE-1213  
Fig 4L**



**Seldin  
LE-1214  
Fig 4R**



**Cryer**  
**LE-1215**  
Fig 3



**Cryer**  
**LE-1216**  
Fig 4



**Cryer**  
**LE-1217**  
Fig 12



**Cryer**  
**LE-1218**  
Fig 27



**Cryer**  
**LE-1219**  
Fig 28



**Cryer**  
**LE-1220**  
Fig 27 S

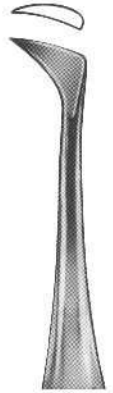

**Cryer**  
**LE-1221**  
Fig 28 S



Apical



Apical  
LE-1222  
Fig 1



Apical  
LE-1223  
Fig 2



Apical  
LE-1224  
Fig 3



Apical  
LE-1225  
Fig 4

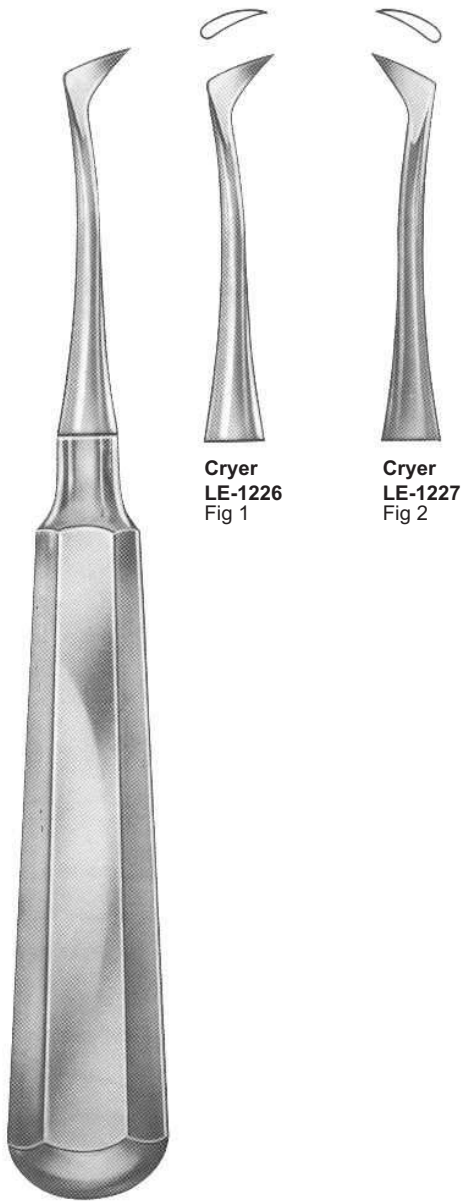

**Cryer**  
**LE-1226**  
Fig 1

**Cryer**  
**LE-1227**  
Fig 2

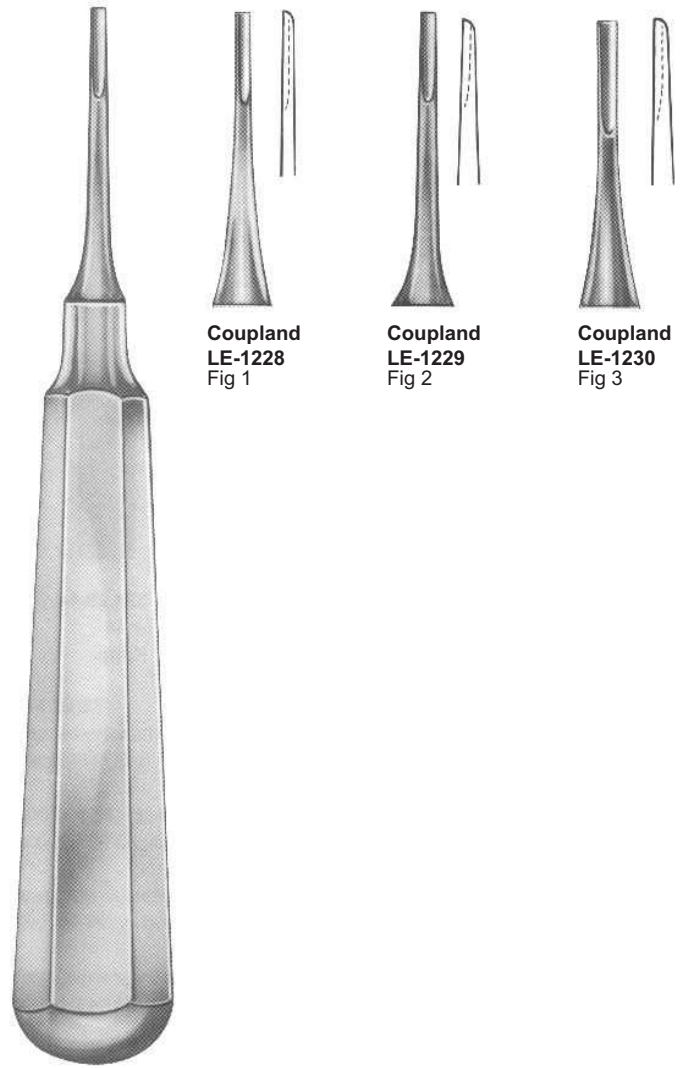

**Coupland**  
**LE-1228**  
Fig 1

**Coupland**  
**LE-1229**  
Fig 2

**Coupland**  
**LE-1230**  
Fig 3

**Cryer**

**Coupland**

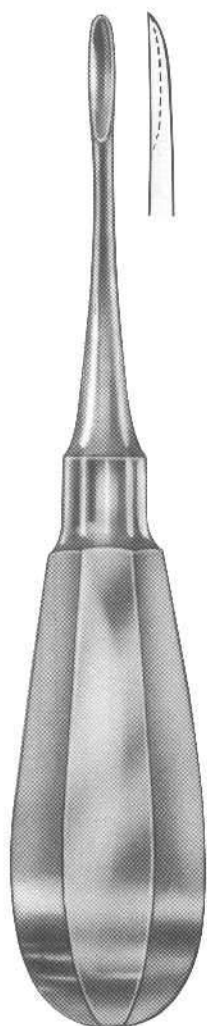

**LE-1231**  
Fig 1

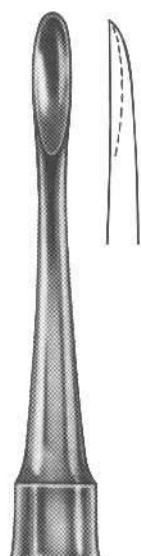

**LE-1232**  
Fig 2

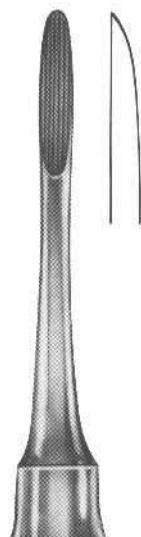

**LE-1233**  
Fig 3

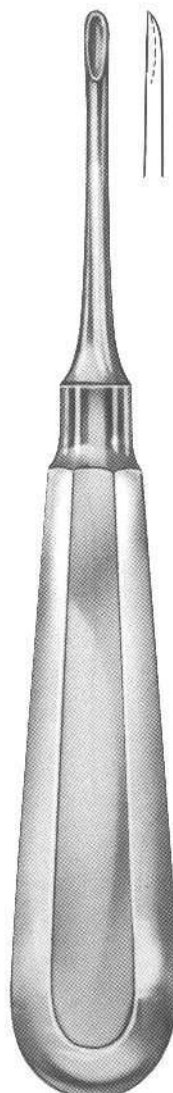

**Flohr**  
**LE-1234**  
Fig 1

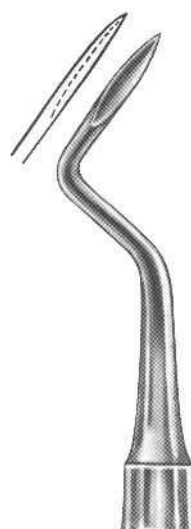

**Flohr**  
**LE-1235**  
Fig 2



**Flohr**  
**LE-1236**  
Fig 3



**Kopp  
LE-1237  
Fig 1**



**Kopp  
LE-1238  
Fig 2**



**Kopp  
LE-1243  
Fig 1**



**Kopp  
LE-1244  
Fig 2**



**Kopp**



**Kopp  
LE-1239  
Fig 3**



**Kopp  
LE-1240  
Fig 4**

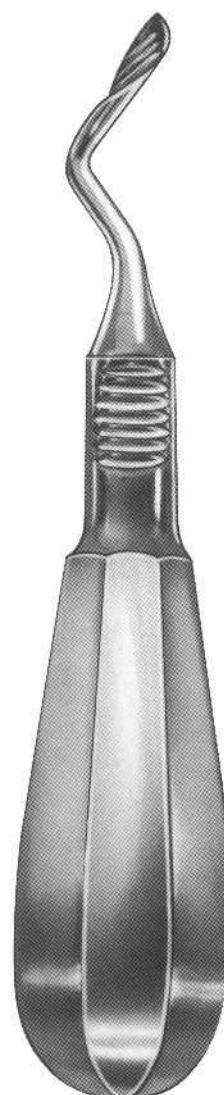

**Kopp**



**Kopp  
LE-1241  
Fig 5**



**Kopp  
LE-1242  
Fig 6**



**Kopp  
LE-1245  
Fig 3**



**Kopp  
LE-1246  
Fig 4**



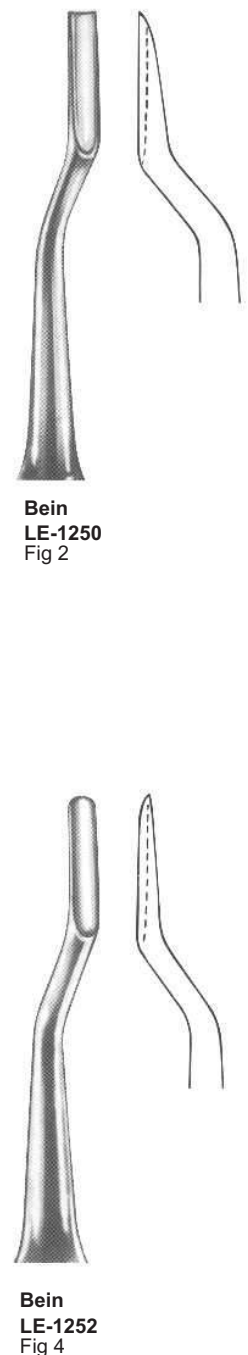
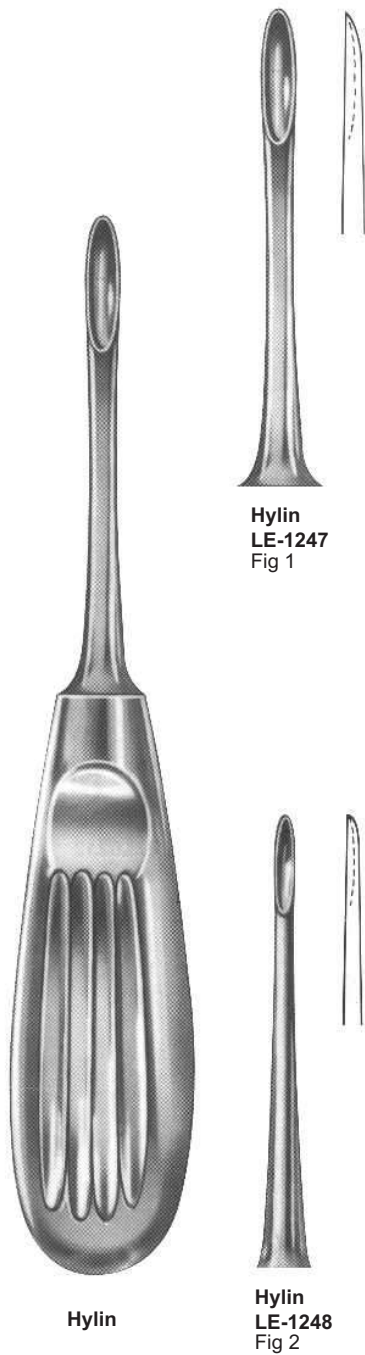



**Warwick-James**  
**LE-1253**  
Fig 1

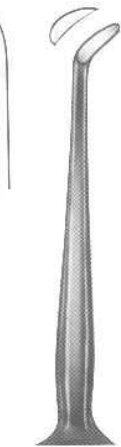

**Warwick-James**  
**LE-1254**  
Fig 2

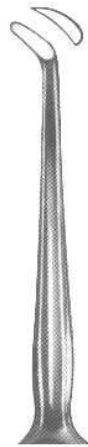

**Warwick-James**  
**LE-1255**  
Fig 3

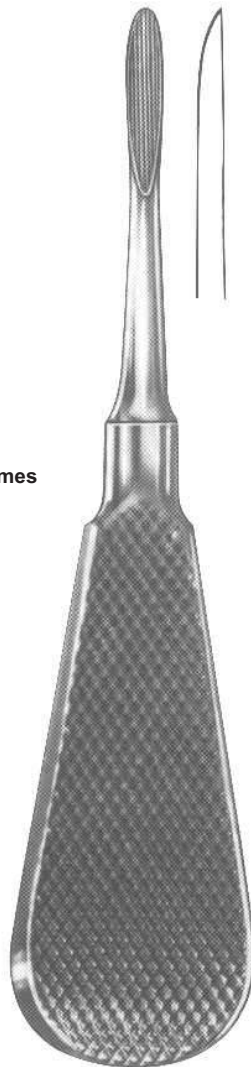

**London Hospital**  
**LE-1256**  
Fig 1



**London Hospital**  
**LE-1257**  
Fig 2



**London Hospital**  
**LE-1258**  
Fig 3

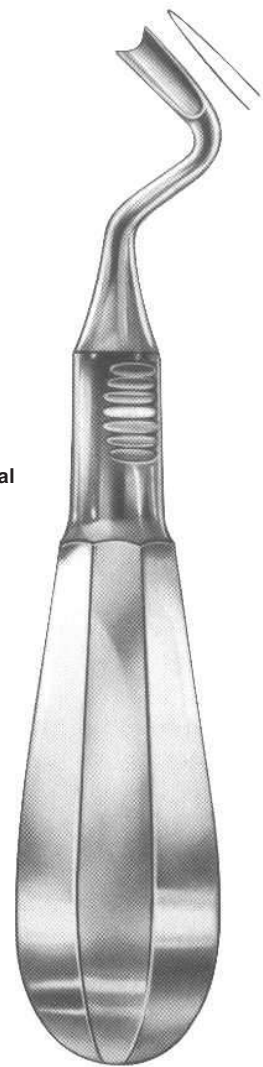

**Ott**  
**LE-1259**

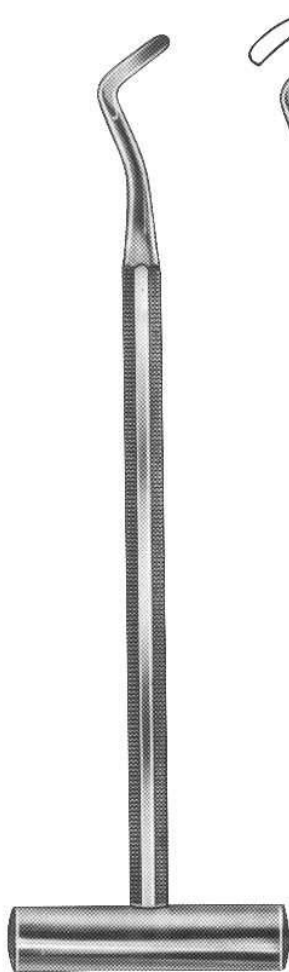

Pott



Pott  
LE-1260  
Fig 1



Pott  
LE-1261  
Fig 2

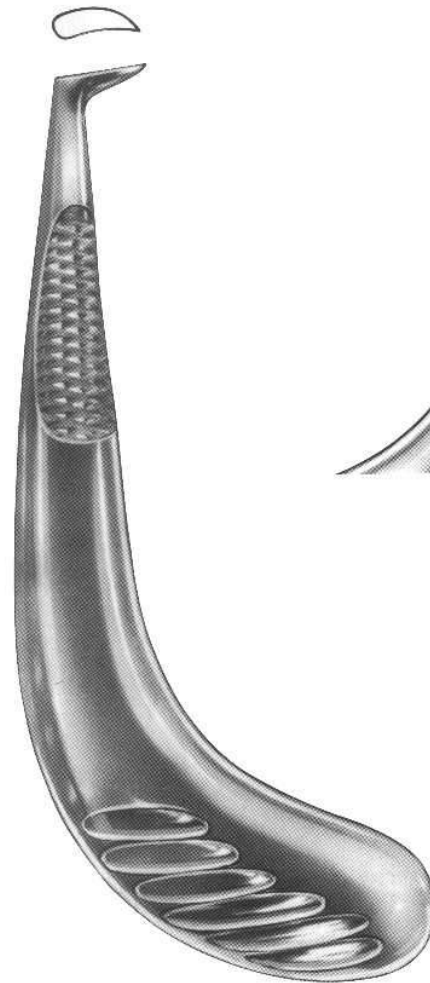

LE-1262  
Fig 1

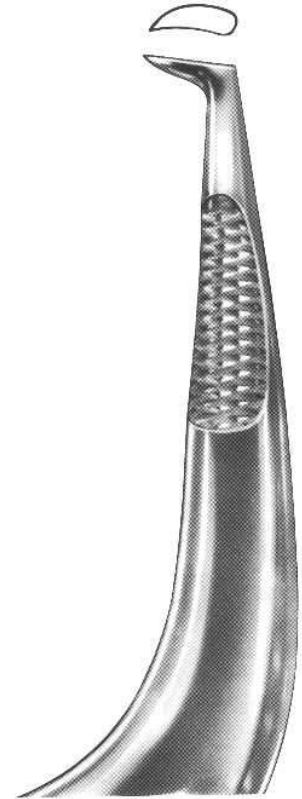

LE-1263  
Fig 2



**Mead**  
**LE-1265**  
MD-5 A



**Mead**  
**LE-1266**  
MD-6 A



**Mead**  
**LE-1267**  
MD-7 A



**Mead**  
**LE-1268**  
MD-8

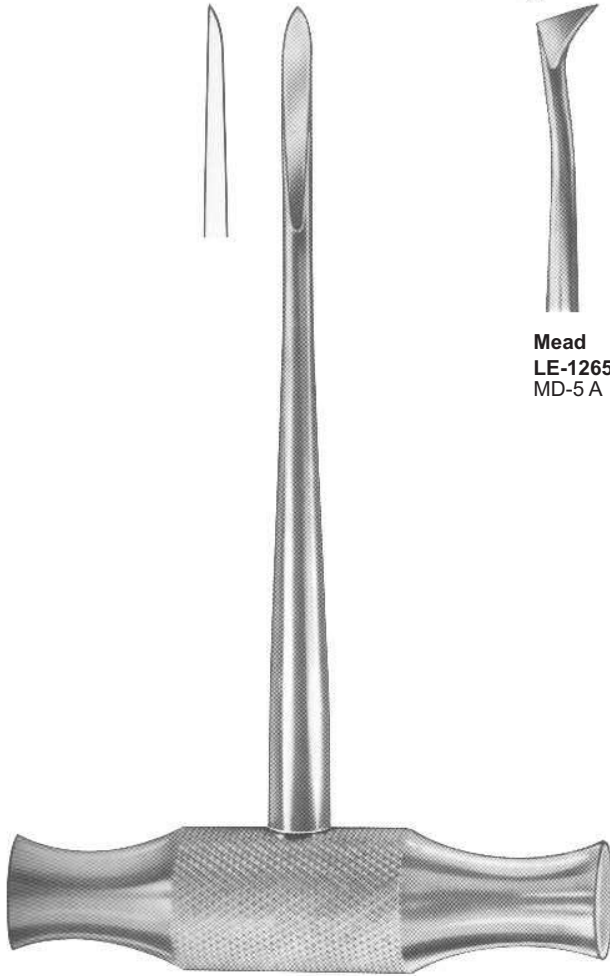

**Mead**  
**LE-1264**  
MD 1

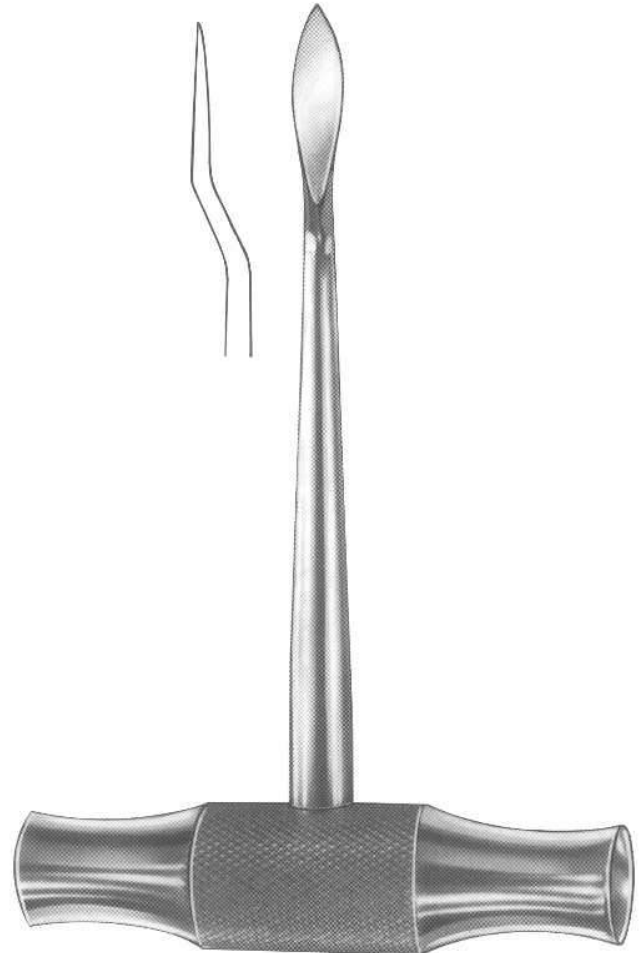

**Lecluse**  
**LE-1269**

Root Elevators



**Chompret  
LE-1270  
Fig 1**



**Chompret  
LE-1271  
Fig 2**



**Chompret  
LE-1272  
Fig 3**



**Chompret  
LE-1273  
Fig 4**



**Apical  
LE-1274**

# Root Elevators, Root Tip Elevators



**LE-1275**  
Fig 1



**LE-1276**  
Fig 2



**LE-1277**  
Fig 3

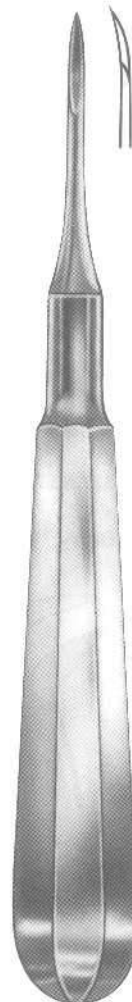

**Heidbrink**  
**LE-1278**  
Fig 1



**Heidbrink**  
**LE-1279**  
Fig 2



**Heidbrink**  
**LE-1280**  
Fig 3



**LE-355**  
1S  
Straight 1mm



**LE-356**  
2S  
Straight 2mm



**LE-357**  
3S  
Straight 3mm



**LE-358**  
5S  
Straight 5mm



**LE-359**  
3C  
Curved 3mm



**LE-360**  
5C  
Curved 5mm



**LE-361**  
3CA  
Curved Angel 3mm



**LE-362**  
3IC  
Inverted Curved 3mm



**LE-363**  
DE3  
Dual Edge 3mm/1.5mm



**LE-364**  
DE5  
Dual Edge 5mm/3mm

## PDL ELEVATORS



**MS-365**  
PDL Elevators  
Set of 7 Pcs



**MS-366**  
PDL Elevators  
Set of 7 Pcs





Winter  
LE-1281  
Fig 1L



Winter  
LE-1282  
Fig 1R



Winter  
LE-1283  
Fig 2L



Winter  
LE-1284  
Fig 2R



Winter



Winter  
LE-1285  
Fig 11 L



Winter  
LE-1286  
Fig 11 R



Winter  
LE-1287  
Fig 12 L



Winter  
LE-1288  
Fig 12 R



Winter  
LE-1289  
Fig 14 L



Winter  
LE-1290  
Fig 14 R



**Barry**  
**LE-1291**  
Fig 1



**Barry**  
**LE-1292**  
Fig 2



**Barry**  
**LE-1293**  
Fig 3



**Barry**  
**LE-1294**  
Fig 4



**Barry**



**Barry**  
**LE-1295**  
Fig 11



**Barry**  
**LE-1296**  
Fig 12



**Barry**  
**LE-1297**  
Fig 17



**Barry**  
**LE-1298**  
Fig 18



Cryer  
LE-1300  
Fig 26



Seldin  
LE-1301  
Fig 27



Cryer  
LE-1302  
Fig 28



Cryer  
LE-1303  
Fig 29



Heidbrink  
LE-1304  
Fig 22



Heidbrink  
LE-1305  
Fig 23



LE-1299



**Kopp**  
**LE-1307**  
Fig 31



**Kopp**  
**LE-1308**  
Fig 32



**Kopp**  
**LE-1309**  
Fig 33



**Kopp**  
**LE-1310**  
Fig 34



**Kopp**  
**LE-1311**  
Fig 35



**Kopp**  
**LE-1312**  
Fig 44



**LE-1306**



**Heidbrink  
1314**  
Fig 10



**Winter  
1315**  
Fig 11



**Winter  
LE-1316**  
Fig 12



**Barry  
LE-1317**  
Fig 17



**Barry  
LE-1318**  
Fig 18



**LE-1319**  
Fig 20



**LE-1313**



LE-1321  
Warwick James Elevators Set of 3



LE-1322  
White Plastic Root Elevators Set of 8



LE-1323  
Cryer Elevators Set of 2



LE-1324  
Luxation Elevators Set of 6



LE-1325  
Coupland Elevators Set of 3



LE-1326  
Potts Elevators Set of 3



LE-1321

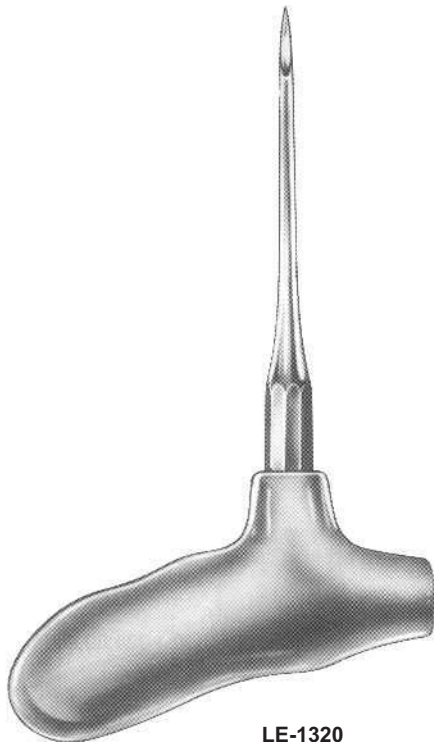

LE-1320



LE-1322



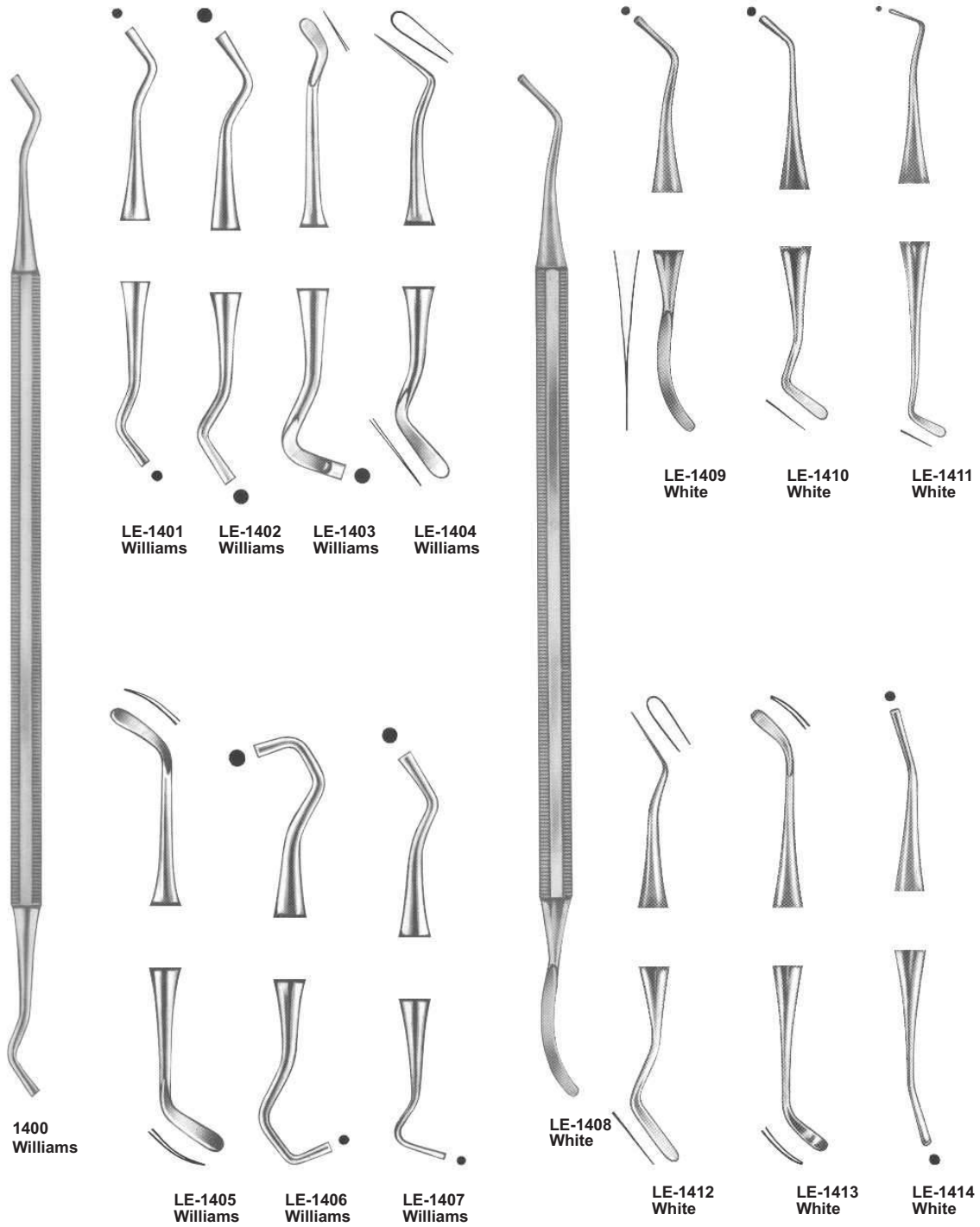

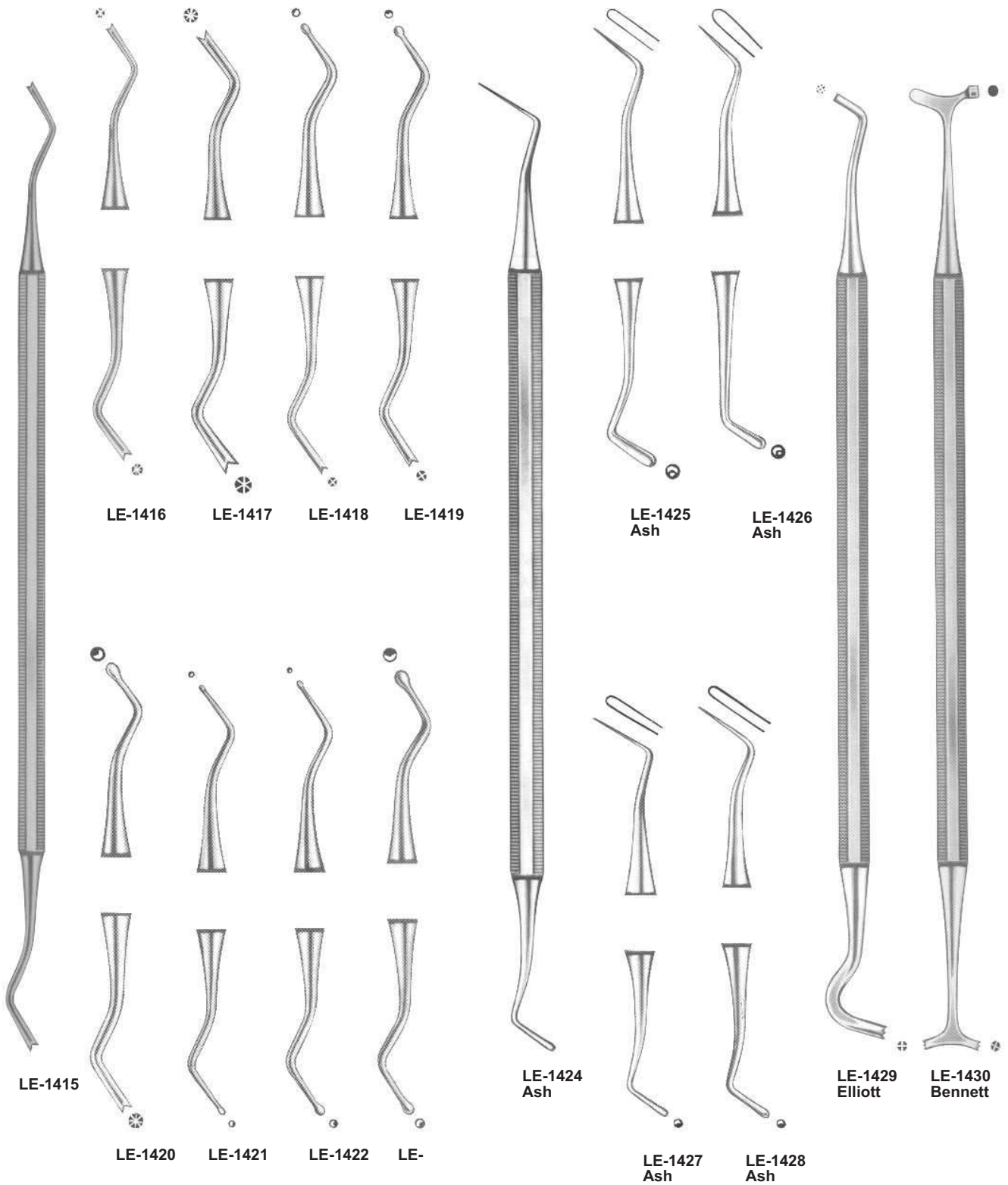

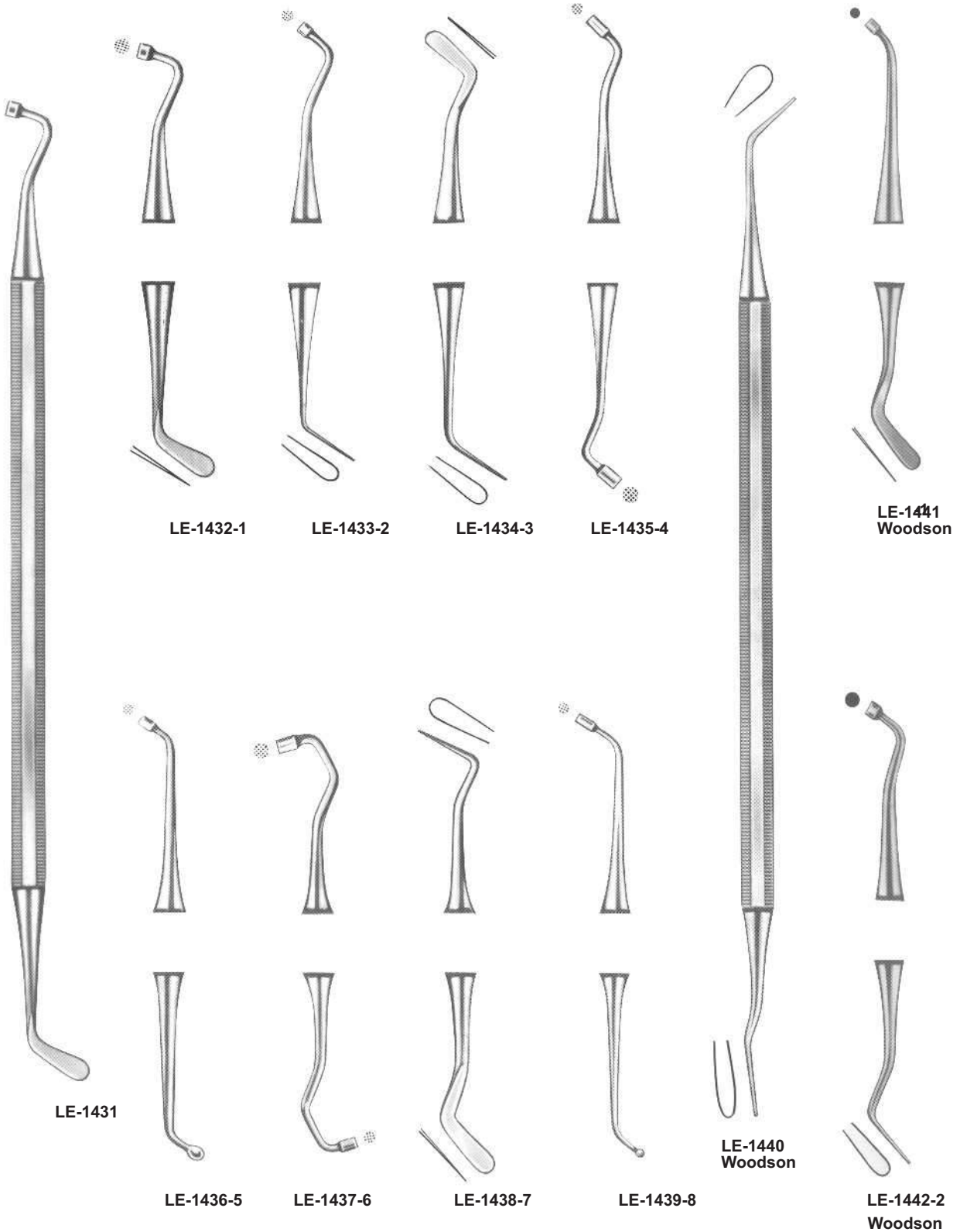



**LE-1443**  
Heidemann  
Fig 1

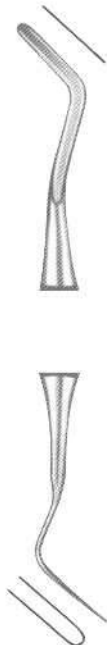

**LE-1444**  
Heidemann  
Fig 2



**LE-1445**  
Heidemann  
Fig 3



**LE-1446**



**LE-1447**  
Fig 146



**LE-1449**  
Fig 148



**LE-1448**  
Fig 147



**LE-1450**  
Fig 149

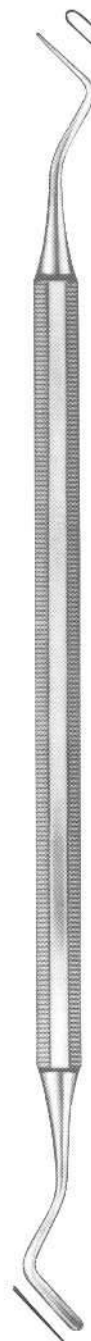

**LE-1451**  
Fig 158

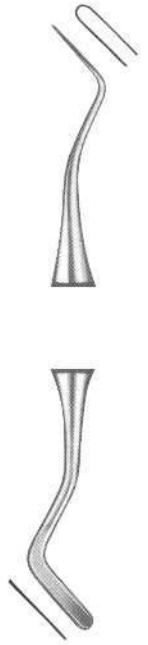

**LE-1452**  
Fig 159

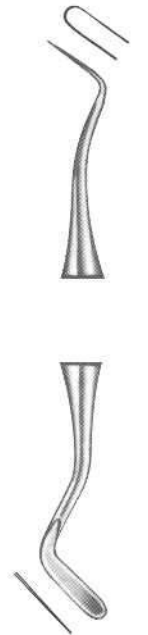

**LE-1453**  
Woodson  
Fig 160

720-1 (Ends: 1.2mm 1.5mm)

721-2 (Ends: 1.9mm 2.2mm)

722-3 (Ends: 2.4mm 2.7mm)

723-4 (Ends: 2.8mm 3.1mm)



**LE-3001**  
Kompositfullung Instrumente

840 ( 2.5mm - 2.5mm )  
841 ( 2mm - 2mm )  
842 ( 1.8mm - 1.8mm )

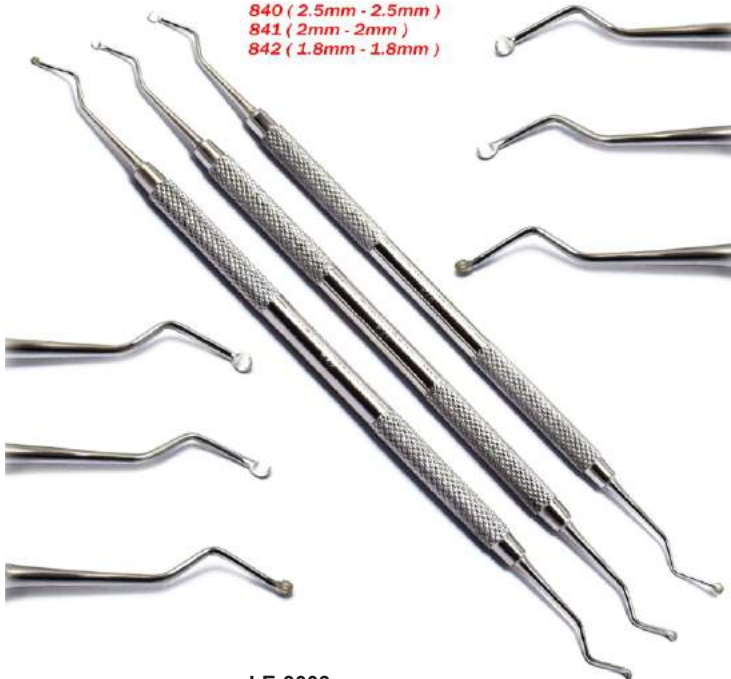

**LE-3003**  
Excavator 809-811-813 Set of 3

**LE-3002**  
Composite Filling Pluggers Set of 4

809-17W ( 1.25mm - 1.25mm )  
811-18W ( 1.50mm - 1.50mm )  
813-19W ( 2mm - 2mm )



**LE-3004**  
Spoon Excavators 840-841-842 Set of 3



**LE-3033**  
CIG 6



**LE-3005**  
Composite Filling Instruments Set of 4 Gold



**LE-3006**  
LM Arte Set of 5



**LE-3007**  
Composite Filling Instruments  
Set of 4 Silicon Handle



**LE-3008**  
Set of 6 Titanium Color Coated  
Composite Filling Instruments



**LE-3009**  
Capsule Applicator



**LE-3010**  
**Composite Filling Instrument 718**



**LE-3011**  
**Composite Filling Instrument 719**



**LE-3012**  
**Westcott Filling 745**



**LE-3013**  
**Westcott Filling 746**



**LE-3030**  
**Ball Burnishers Set of 5**



LE-3014



LE-3015  
Football Burnisher 751

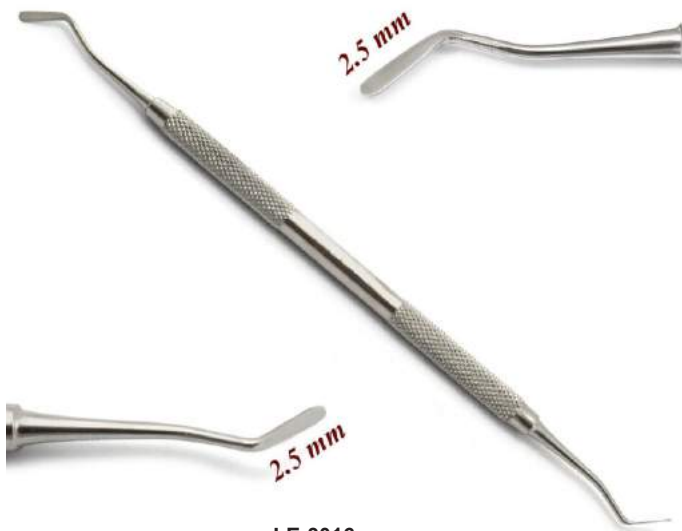

LE-3016  
Flat Plastic 754

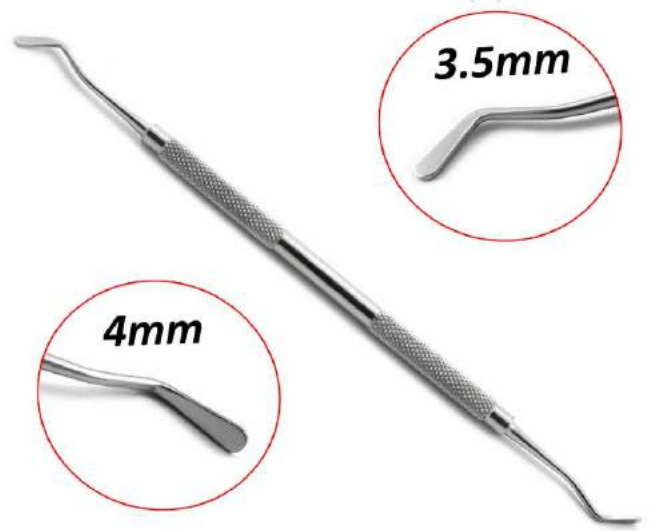

LE-3017  
Flat Plastic 756



LE-3018  
Excavator 822-823 Set of 2





LE-3101  
PK Thomas wax carvers Set of 5



3mm  
2.5mm  
2mm



LE-3102  
Heidmann Spatula Set of 3



LE-3103  
Hollenbeck Carvers



LE-3104  
Points



LE-5101  
**Orban Knife Set of 3**



LE-5102  
**Goldman Fox Knife Set of 3**



LE-5103  
**Cord Packer Set of 3**



LE-5104



LE-5105



LE-5106



51-3207



**LE-1454**  
Gracey



**LE-1455**  
Gracey  
Fig 1



**LE-1456**  
Gracey  
Fig 2

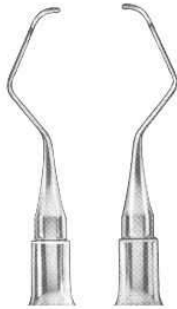

**LE-1457**  
Gracey  
Fig 3

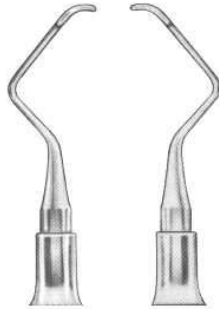

**LE-1458**  
Gracey  
Fig 4



**LE-1459**  
Gracey  
Fig 5

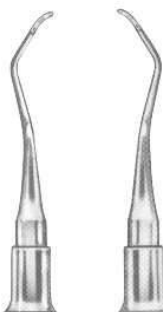

**LE-1460**  
Gracey  
Fig 6



**1461**



**LE-1462-1**  
Fig 18



**LE-1463-2**  
Fig 19



**LE-1464-3**  
Fig 20



**LE-1465-4**  
Fig 22



**LE-1466-5**  
Fig 23



**LE-1467-6**  
Fig 25



**LE-1468-7**  
Fig 26



**LE-1469-8**  
Fig 27





LE-3301  
Periotome Gold Set of 4

LE-3302  
Periotome Titanium Super Flex Set of 3



LE-3303  
Pt1 & PT2 Set



LE-3304  
PPAEL & PPAELA set of 2



LE-3305  
Periotome Titanium Screw Point



LE-3401  
Sickle Scaler



LE-3402  
Explorer DG 16 Blue



LE-3403  
Explorer DG 16 Silver



LE-3404  
jaquette Scaler 31 32



LE-3405  
Tartar Remover



LE-3501  
**CP 15 Probe**



LE-3502  
**WHO Probe**

With Point Set In



LE-1470



LE-1471-1



LE-1472-2



LE-1473-3



LE-1474-4



LE-1475-5



LE-1476-6



LE-1477-7



LE-1478-8



LE-1479-9



LE-1480-10



LE-1481-11



LE-1482-12  
Woodson



Polishing Instruments

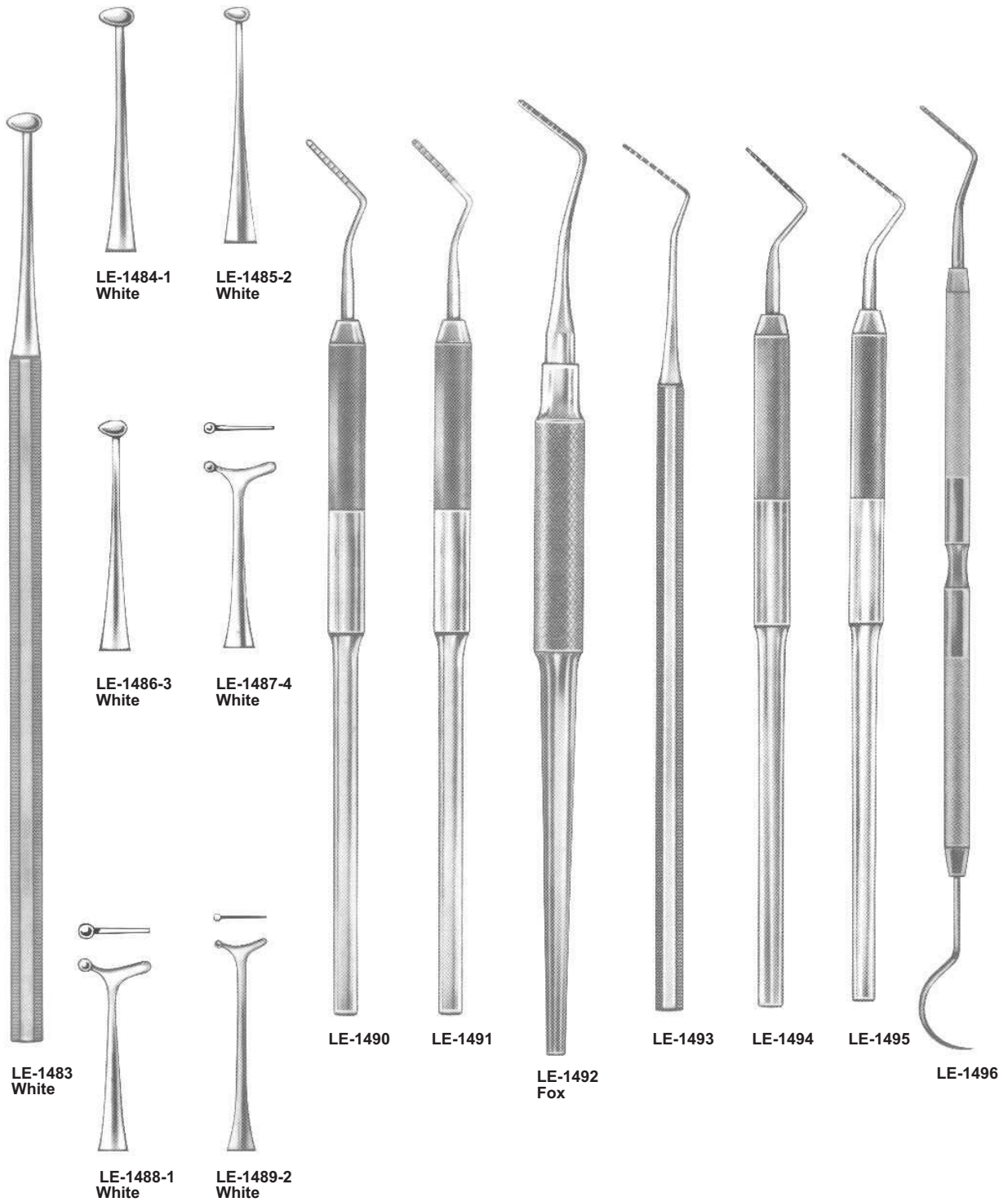



- New marking process.
- Laser system marking.
- No more paint peeling off.
- Permanent marking.
- Antiglare, low depth marking.
- Maximum tip resistance against breaking.



**LE-1497**  
Fig CP-C



**LE-1498**  
Fig CP-11



**LE-1499**  
Fig CP-12



**LE-1500**  
Fig CP-12S  
O.M.S



**LE-1501**  
Williams

**LE-1502**  
Merrit A

**LE-1503**  
Merrit B

**LE-1504**  
Goldman  
Fox

**LE-1505**  
University of  
Michigan

**LE-1506**  
26 G

Files

Chisels



**LE-1507**  
Sugarman  
Fig. 1S/2S



**LE-1508**  
Sugarman  
Fig. 3S/4S



**LE-1509**  
Schluger  
Fig. 9/10



**LE-1510**  
Buck  
Fig. 11/12



**LE-1511**  
Ochsenbein  
Fig. 3



**LE-1512**  
Ochsenbein  
Fig. 4



**LE-1513**  
Rhodes  
Back - Action  
Fig. 36/37

Files

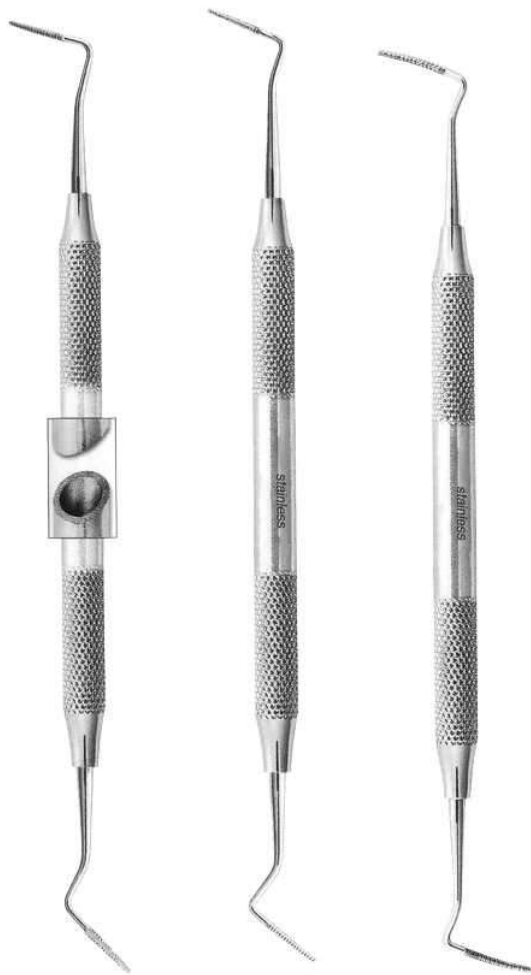

**LE-1514**  
Sugarman  
Fig. 1S/2S

**LE-1515**  
Sugarman  
Fig. 3S/4S

**LE-1516**  
Schluger  
Fig. 9/10



**LE-1517**  
Buck  
Fig. 11/12



**LE-1518**  
Ochsenbein  
Fig. 3



**LE-1519**  
Ochsenbein  
Fig. 4



**LE-1520**  
Rhodes  
Back - Action  
Fig. 36/37

## Gingivectomy knives



**LE-1521**  
Goldman-Fox  
Fig. 7

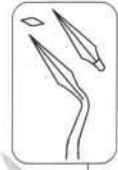

**LE-1522**  
Goldman-Fox  
Fig. 8



**LE-1523**  
Goldman-Fox  
Fig. 9



**LE-1524**  
Goldman-Fox  
Fig. 11



**LE-1525**  
Buck  
Fig. 3/4



**LE-1526**  
Buck  
Fig. 5/6

Curettes and Scalers



**LE-1527**  
Curette  
Fig. HU 1/2



**LE-1528**  
Columbia  
Fig. 2R/2L



**LE-1529**  
Columbia  
Fig. 4R/4L



**LE-1530**  
Columbia  
Fig. 13/14



**LE-1531**  
Fig. 411/412



**LE-1532**  
Fig. 413/414



**LE-1533**  
Zerfing-chisel

## Gingivectomy knives



**LE-1534**  
Goldman - Fox  
Fig. 7

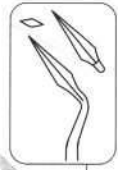

**LE-1535**  
Goldman - Fox  
Fig. 8



**LE-1536**  
Goldman - Fox  
Fig. 9



**LE-1537**  
Goldman - Fox  
Fig. 11



**LE-1538**  
Buck  
Fig. 3/4

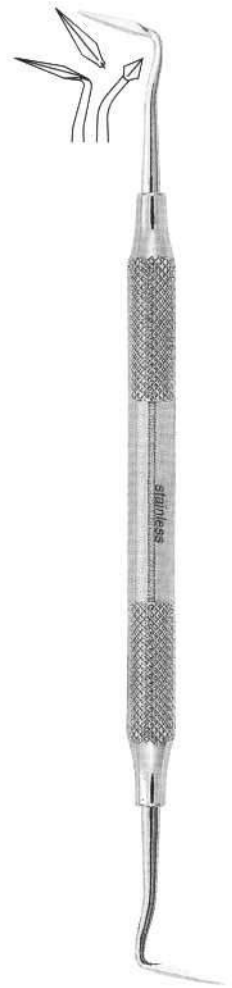

**LE-1539**  
Buck  
Fig. 5/6



Curettes and Scalers



**LE-1540**  
Curette  
Fig. HU 1/2



**LE-1541**  
Columbia  
Fig. 2R/2L



**LE-1542**  
Columbia  
Fig. 4R/4L



**LE-1543**  
Columbia  
Fig. 13/14



**LE-1544**  
Fig. 413/412



**LE-1545**  
Fig. 411/414



**LE-1546**  
Zerfing-chisel

Bone Chisels and Gouges

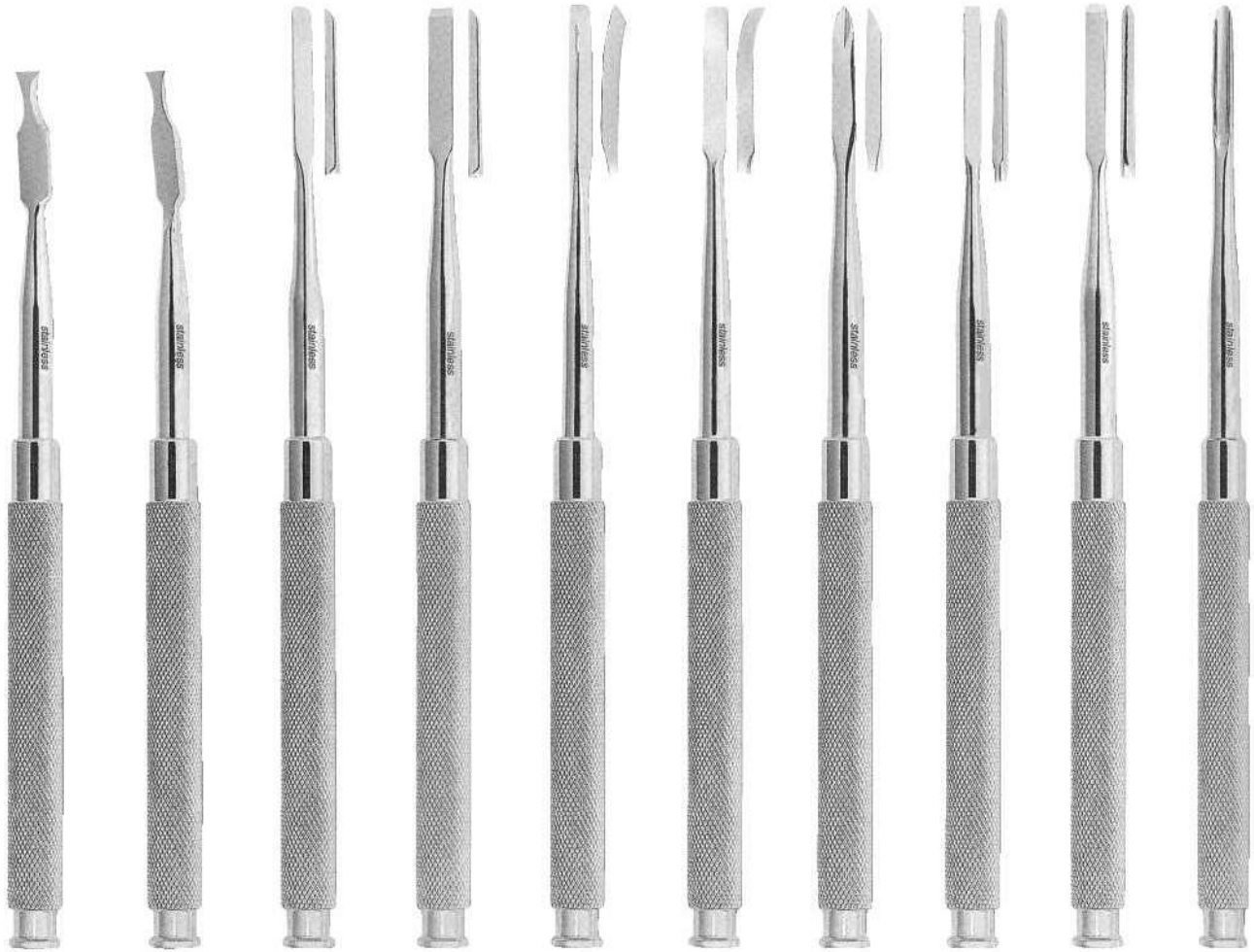

**LE-1547**  
Ochsenbein  
Fig. 1

**LE-1548**  
Ochsenbein  
Fig. 2

**LE-1549**  
Gardner  
Fig. 1

**LE-1550**  
Gardner  
Fig. 2

**LE-1551**  
Gardner  
Fig. 5

**LE-1552**  
Gardner  
Fig. 5R

**LE-1553**  
Gardner  
Fig. 6

**LE-1554**  
Wakefield  
Fig. 1W

**LE-1555**  
Wakefield  
Fig. 2W

**LE-1556**  
Buckley  
Fig. 3

Bone Chisels and Gouges

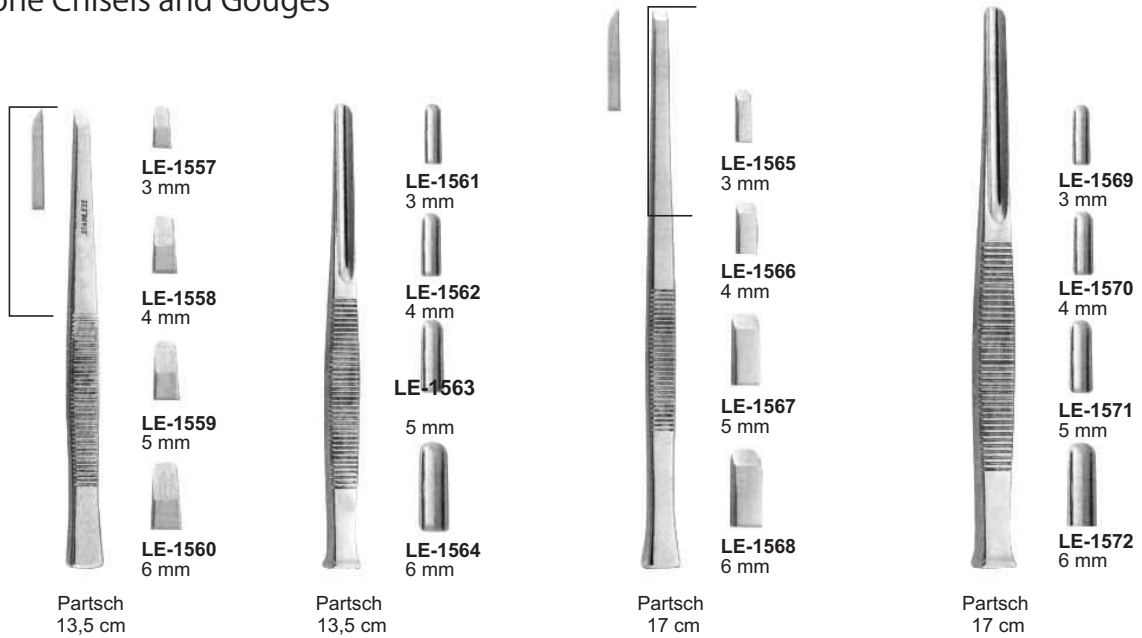

Martelli chirurgici  
Mallet

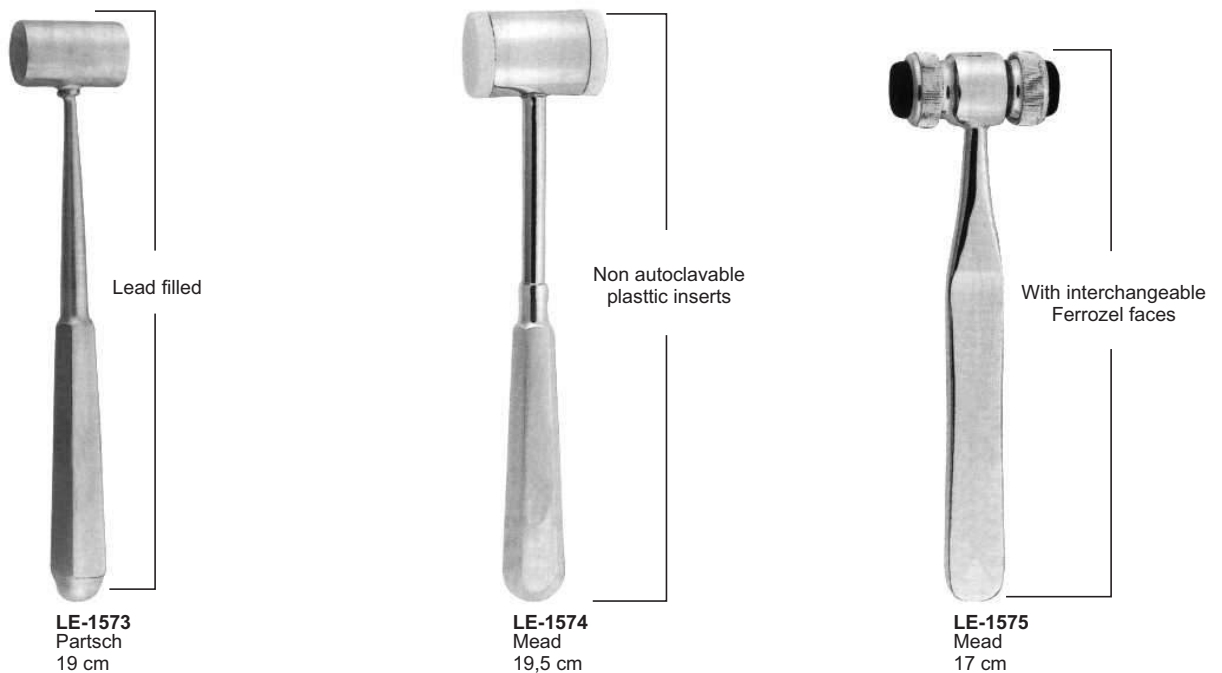

# Gracey Currettes

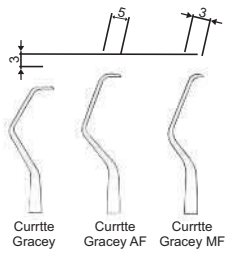

**LE-1576**  
Gracey  
Fig. 1/2



**LE-1577**  
Gracey  
Fig. 3/4



**LE-1578**  
Gracey  
Fig. 5/6



**LE-1579**  
Gracey  
Fig. 7/8



**LE-1580**  
Gracey  
Fig. 9/10



**LE-1581**  
Gracey  
Fig. 11/12



**LE-1582**  
Gracey  
Fig. 13/14



**LE-1583**  
Gracey  
Mesial Distal  
Fig. 11/14



**LE-1584**  
Gracey  
Mesial Distal  
Fig. 12/13

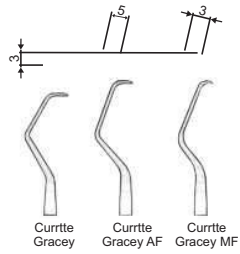

**LE-1585**  
Gracey  
AF/type  
Fig. 1/2



**LE-1586**  
Gracey  
AF/type  
Fig. 3/4



**LE-1587**  
Gracey  
AF/type  
Fig. 5/6



**LE-1588**  
Gracey  
AF/type  
Fig. 7/8



**LE-1589**  
Gracey  
AF/type  
Fig. 11/12



**LE-1590**  
Gracey  
AF/type  
Fig. 13/14



**LE-1591**  
Gracey  
AF/type  
Fig. 15/16

# Gracey Currettes, AF, MF, Type



**LE-1592**  
Gracey  
AF/type



**LE-1593**  
Gracey  
AF/type  
Fig. 1/2



**LE-1594**  
Gracey  
AF/type  
Fig. 3/4



**LE-1595**  
Gracey  
AF/type  
Fig. 5/6



**LE-1596**  
Gracey  
AF/type  
Fig. 7/8



**LE-1597**  
Gracey  
AF/type  
Fig. 11/12



**LE-1598**  
Gracey  
AF/type  
Fig. 13/14



**LE-1599**  
Gracey  
AF/type  
Fig. 15/16



**LE-1600**  
Gracey  
MF/type  
Fig. 1/2



**LE-1601**  
Gracey  
MF/type  
Fig. 3/4



**LE-1602**  
Gracey  
MF/type  
Fig. 5/6



**LE-1603**  
Gracey  
MF/type  
Fig. 7/8



**v1604**  
Gracey  
MF/type  
Fig. 11/12



**LE-1605**  
Gracey  
MF/type  
Fig. 13/14



**LE-1606**  
Gracey  
MF/type  
Fig. 15/16

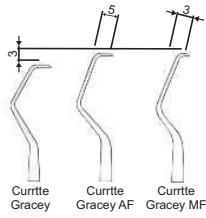

**LE-1607**  
Gracey  
MF/type  
Fig. 1/2



**LE-1608**  
Gracey  
MF/type  
Fig. 3/4

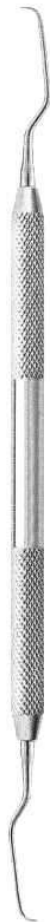

**LE-1609**  
Gracey  
MF/type  
Fig. 5/6



**LE-1610**  
Gracey  
MF/type  
Fig. 7/8



**LE-1611**  
Gracey  
MF/type  
Fig. 11/12



**LE-1612**  
Gracey  
MF/type  
Fig. 13/14



**LE-1613**  
Gracey  
MF/type  
Fig. 15/16

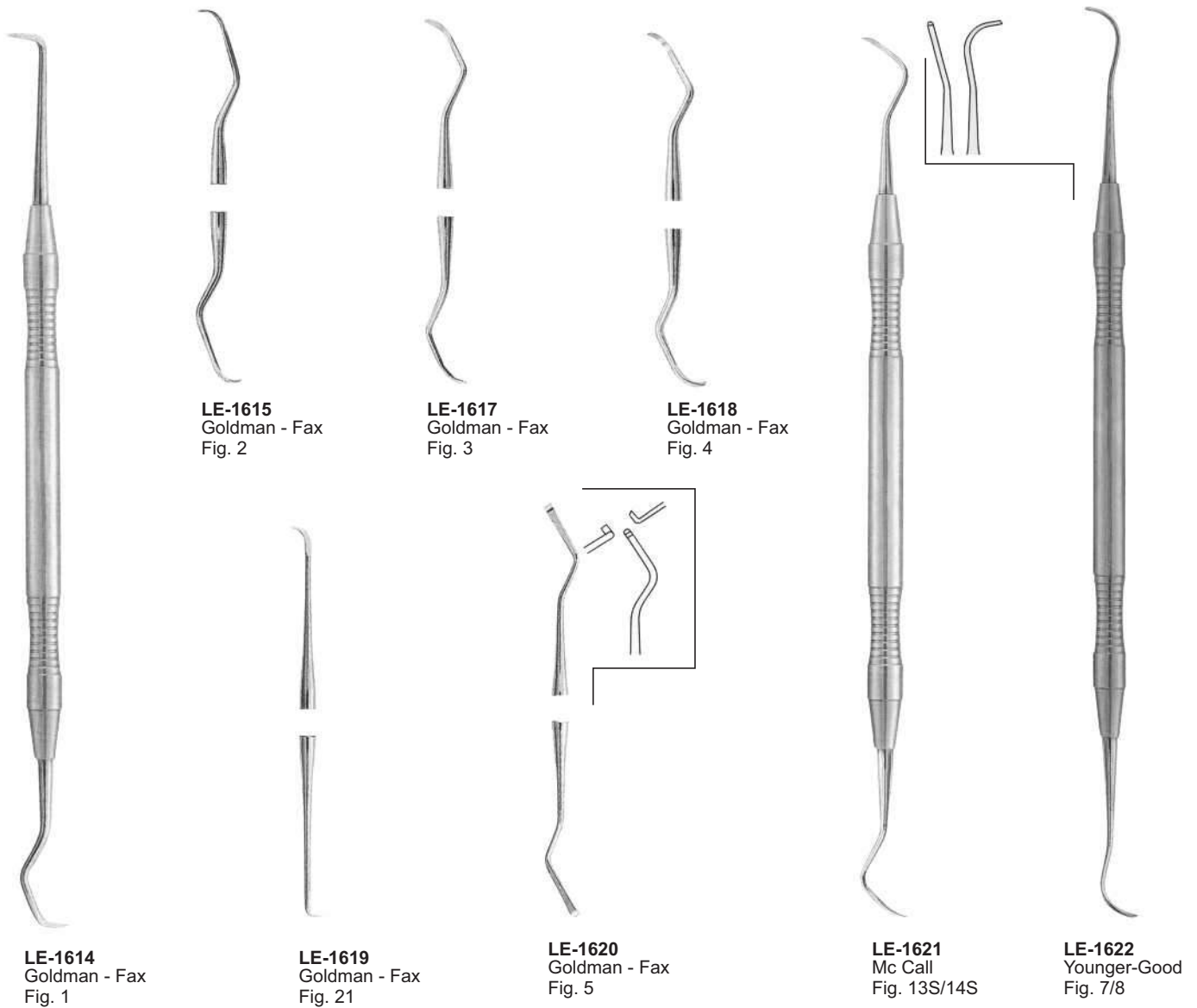





**LE-1623**  
Towner  
Fig. U15

**LE-1624**  
Crane - Kaplan  
Fig. 6

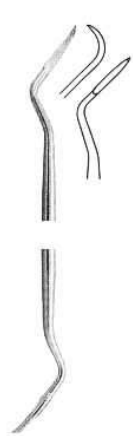

**LE-1625**  
Crane - Kaplan  
Fig. 6S



**LE-1626**  
Taylor  
Fig. 2/3



**LE-1627**  
Fig. 204S



**LE-1628**  
Towner Jaquette  
Fig. U15/33



**LE-1633**  
Jaquette  
Fig. 2

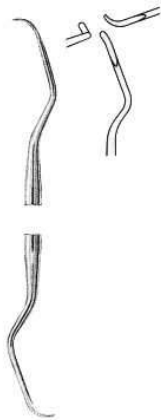

**LE-1629**  
Columbia  
Fig. 2R/2L



**LE-1630**  
Columbia  
Fig. 4R/4L



**LE-1631**  
Columbia  
Fig. 13/14



**LE-1632**  
Jaquette  
Fig. 1



**LE-1634**  
Jaquette  
Fig. 3

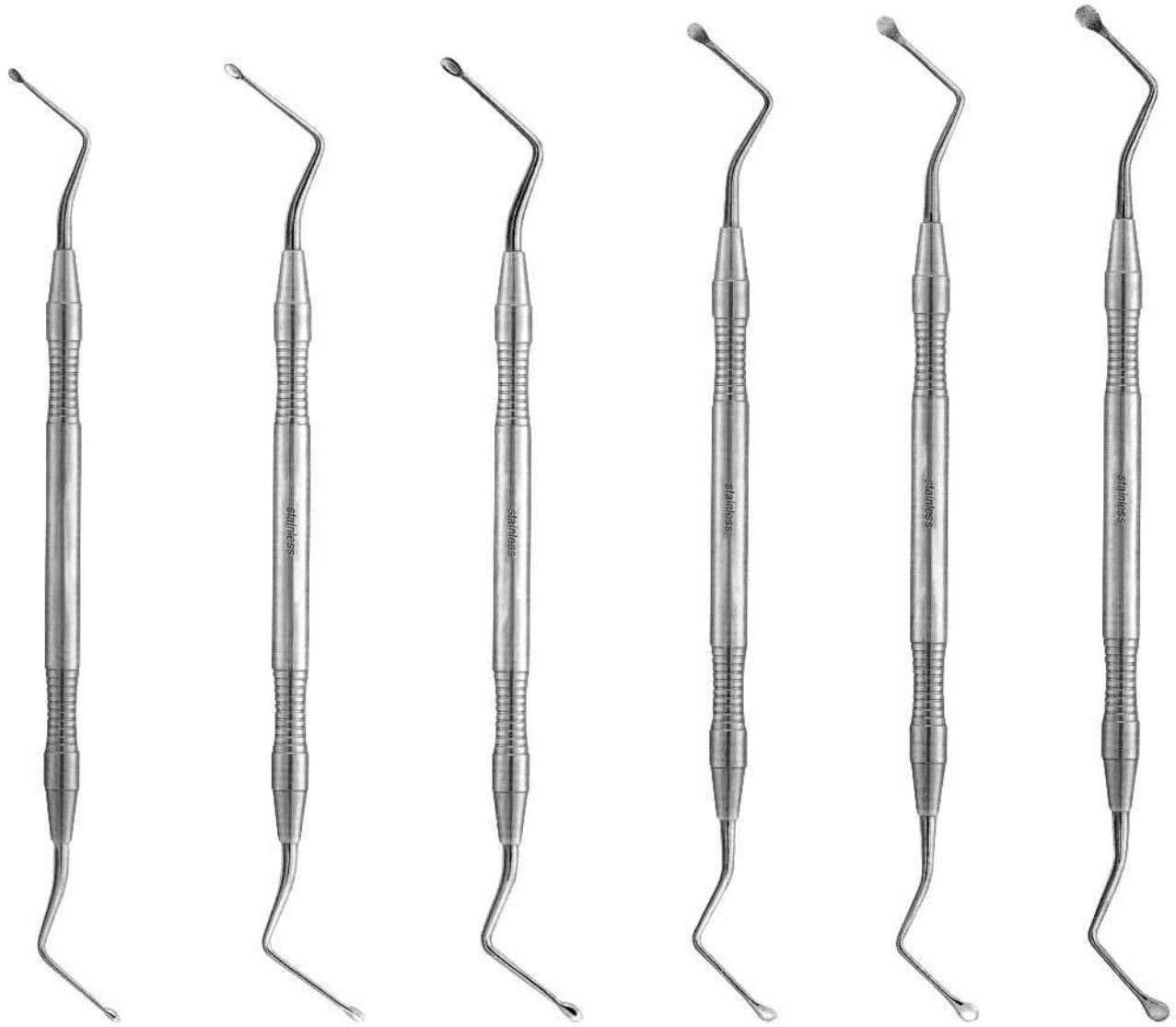

**LE-1635**  
Hemingway  
Fig. 1

**LE-1636**  
Hemingway  
Fig. 2

**LE-1637**  
Hemingway  
Fig. 3

**LE-1638**  
Lucas  
Fig. 85

**LE-1639**  
Lucas  
Fig. 86

**LE-1640**  
Lucas  
Fig. 87

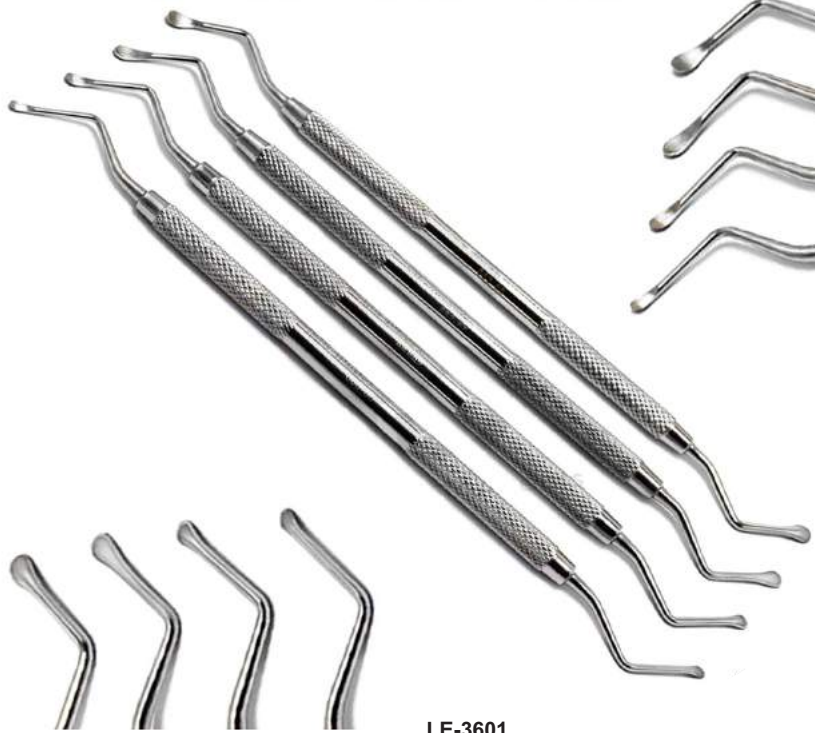

LE-3601



LE-3602

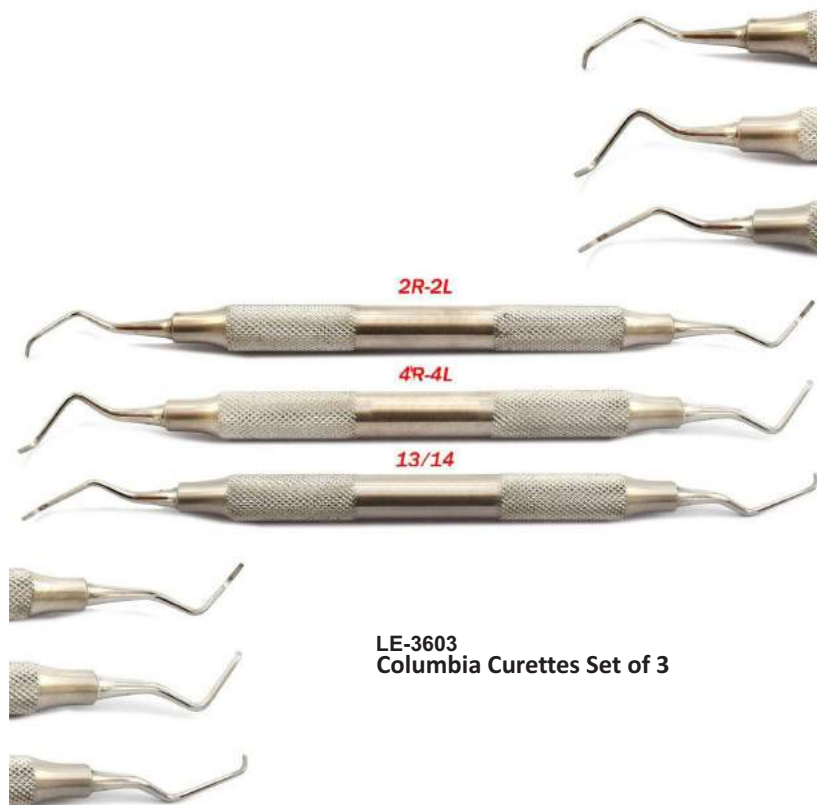

LE-3603  
Columbia Currettes Set of 3

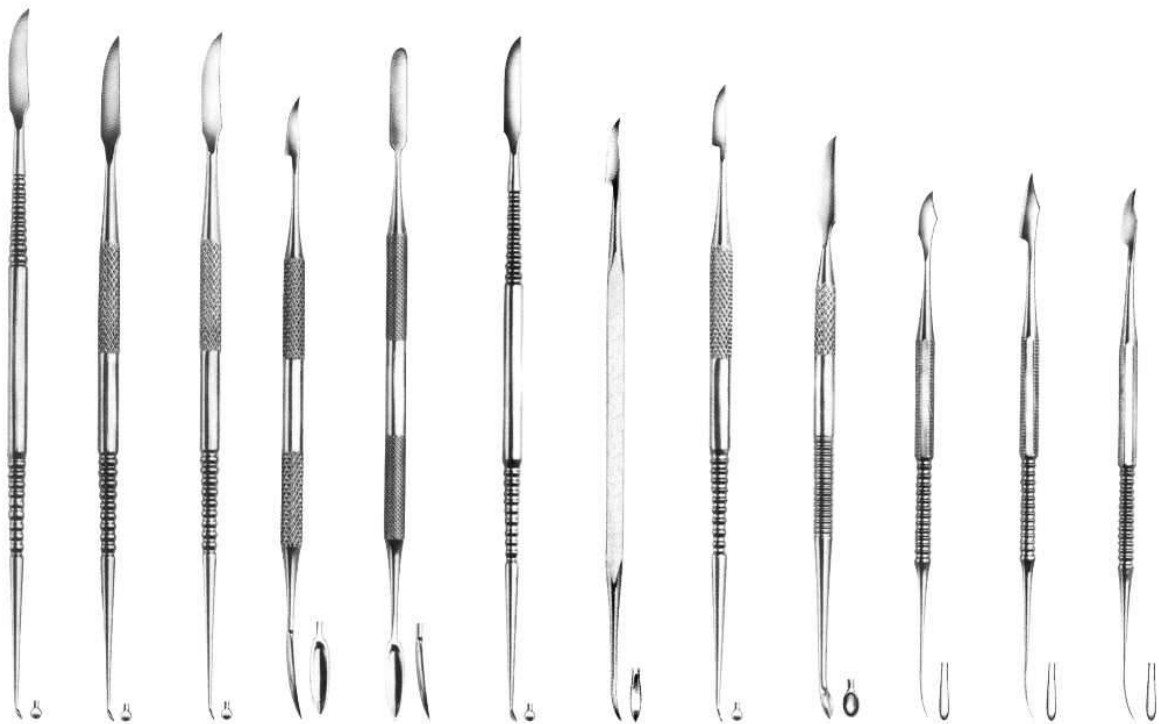

**LE-1641** Le Cron    **LE-1642** Le Cron    **LE-1643** Le Cron    **LE-1644** MSY    **LE-1645** MSY    **LE-1646** Le Cron    **LE-1647** Hylin    **LE-1648** Hylin    **LE-1649** Hylin    **LE-1650** Zahle    **LE-1651** Zahle    **LE-1652** Zahle

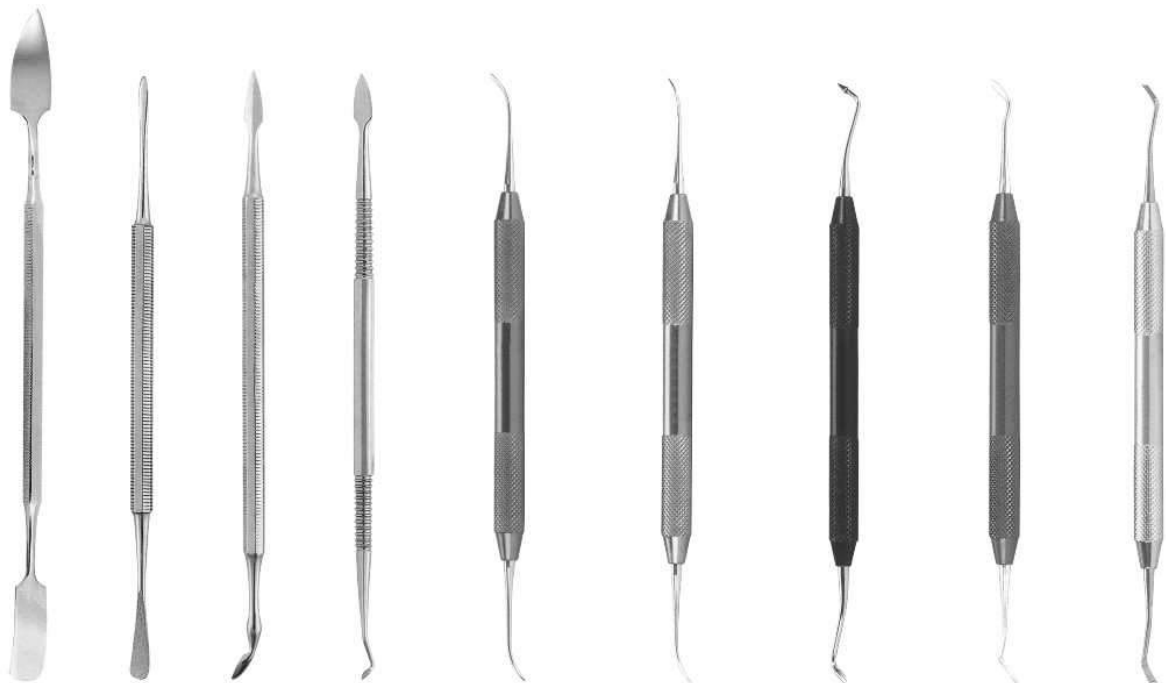

**LE-1653** Gritman    **LE-1654** Beale    **LE-1655** Roach    **LE-1656** Vehe    **LE-1657** P.K. Thomas Fig. 1    **LE-1658** P.K. Thomas Fig. 2    **LE-1659** P.K. Thomas Fig. 3    **LE-1660** P.K. Thomas Fig. 4    **LE-1661** P.K. Thomas Fig. 5

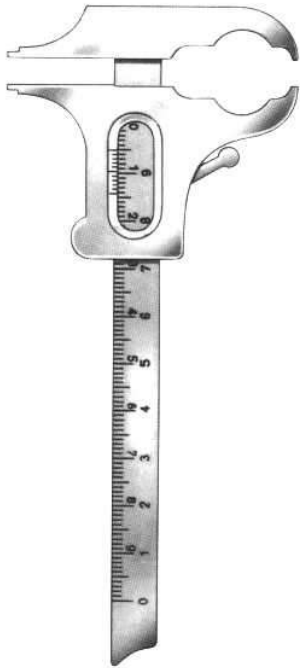

**LE-1662**  
Boley



**LE-1663**  
Zuricher  
130 mm

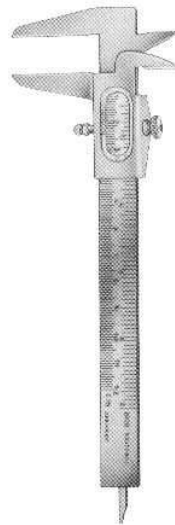

**LE-1664**  
Vernier  
12 cm



**LE-1665**  
Vernier

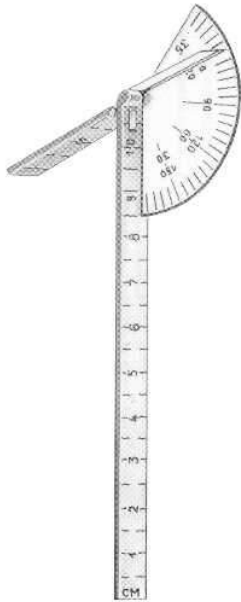

**LE-1666**  
Caroll



**LE-1667**  
Castroviejo's  
Scleral Marker



**LE-1668**  
Iwanson

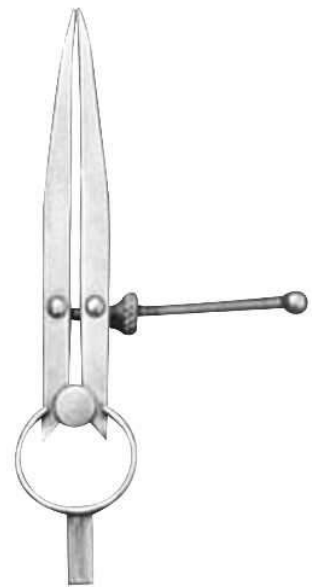

**LE-1669**  
Albee

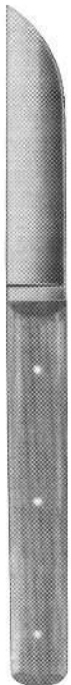

**LE-1700**  
18 cm  
7 1/8"



**LE-1701**  
18 cm  
7 1/8"



**LE-1702**  
17 cm  
6 3/4"  
Gritman

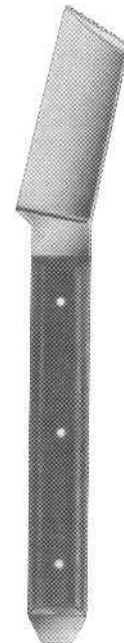

**LE-1703**  
17 cm  
6 3/4"  
Medicon



**LE-1704**  
22 cm  
8 3/4"



**LE-1705**  
Antkoviak



**LE-1706**  
Ermert



**LE-1707**  
Ermert



**LE-1708**  
 Fahnenstock  
 Fig. 1  
 12,5cm



**LE-1709**  
 Fahnenstock  
 Fig. 2  
 17cm



**LE-1710**  
 Lessmann  
 Fig. 1  
 12,5cm



**LE-1711**  
 Lessmann  
 Fig. 2  
 17cm



**LE-1712**  
 Con scodellino  
 Fig. 1  
 12,5cm



**LE-1713**  
 Con scodellino  
 Fig. 2  
 17cm



**LE-1714**  
Fig. 1  
17 cm



**LE-1715**  
Gritman  
Fig. 2  
17 cm



**LE-1716**  
Fig. 3  
16 cm



**LE-1717**  
Fig. 4  
16 cm



Explorers



**LE-1800**  
Fig 23



**LE-1801**  
Fig 6



**LE-1802**  
Fig 8



**LE-1803**  
Fig 9



**LE-1804**  
Fig 17



**LE-1805**  
Fig 3  
Rein



**LE-1806**  
Fig 23/17



**LE-1807**  
Fig 17

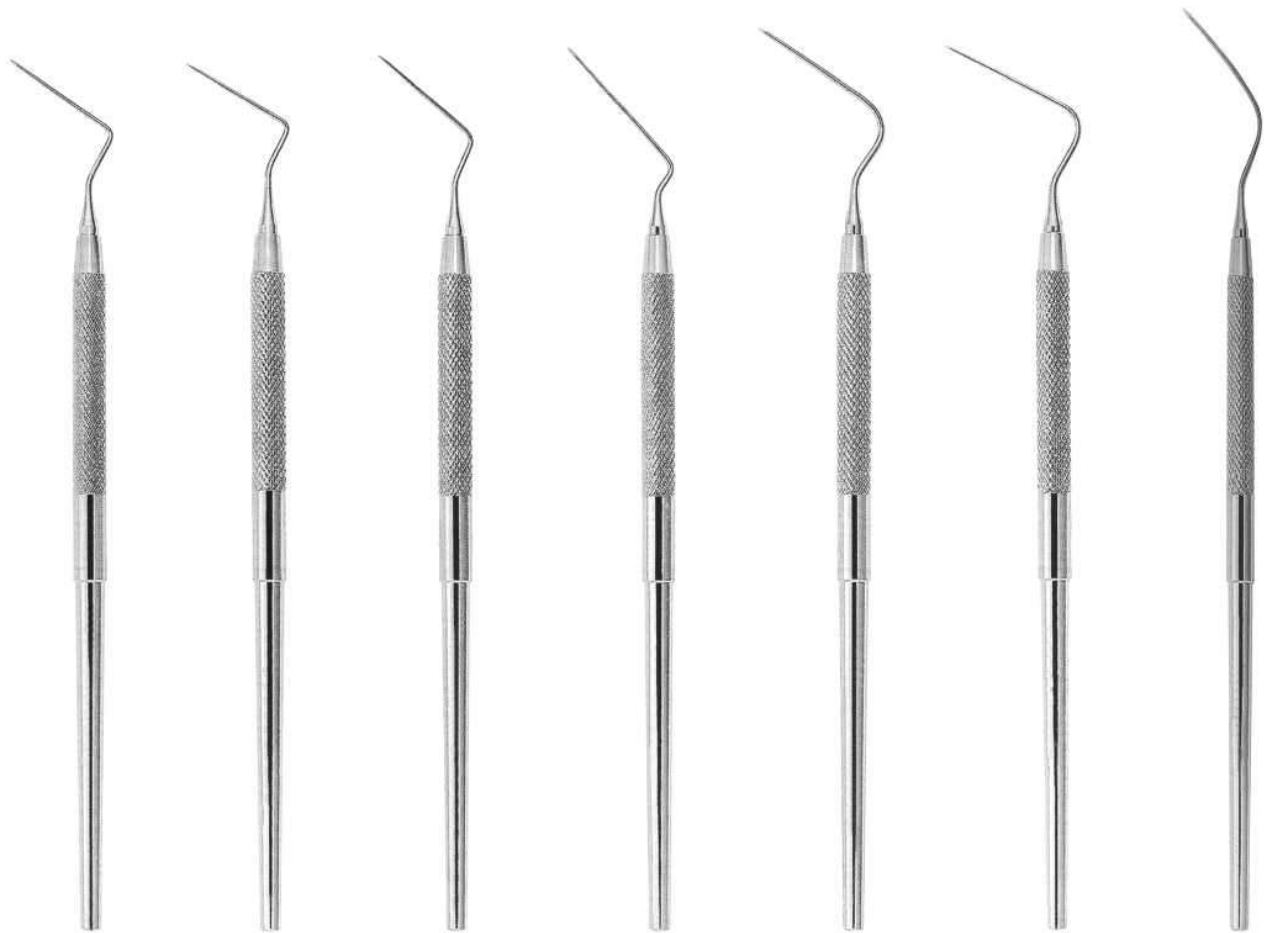

**LE-1808**  
Fig.1  
Spreader

**LE-1809**  
Fig.2  
Spreader

**LE-1810**  
Fig.3  
Spreader

**LE-1811**  
Fig.4  
Spreader

**LE-1812**  
Fig.5  
Spreader

**LE-1813**  
Fig.6  
Spreader

**1814**  
Fig.7  
Spreader

Double-Ended Root Canal  
Explorers Plugger/Spreaders

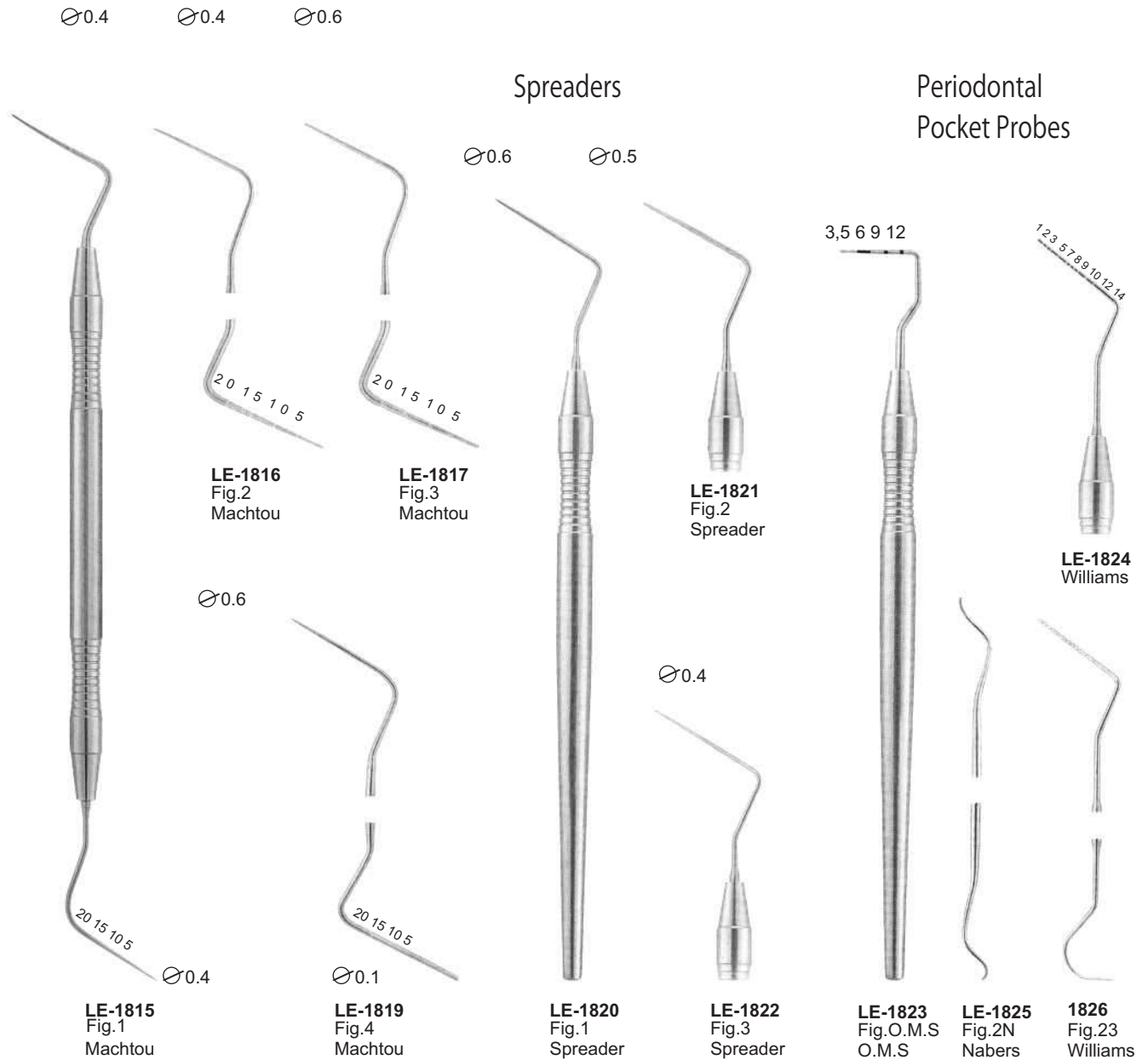

## Root-canal pluggers

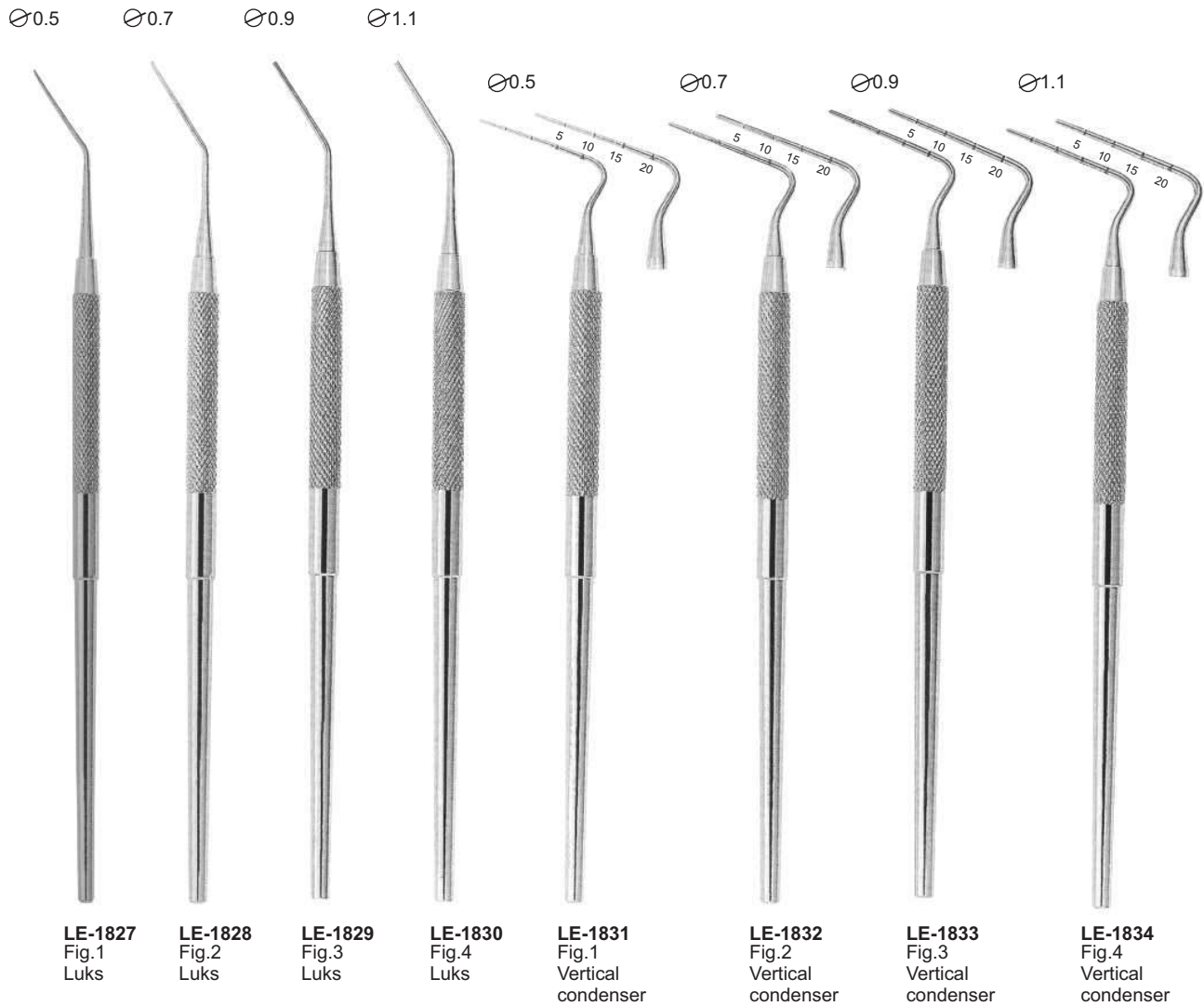

Endodontic set

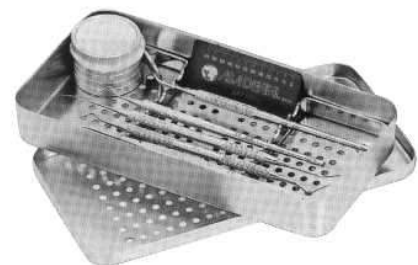

**1835**  
Measuring Plate

Root-canal pluggers

Optimum Flexibility  
Very Fine Points

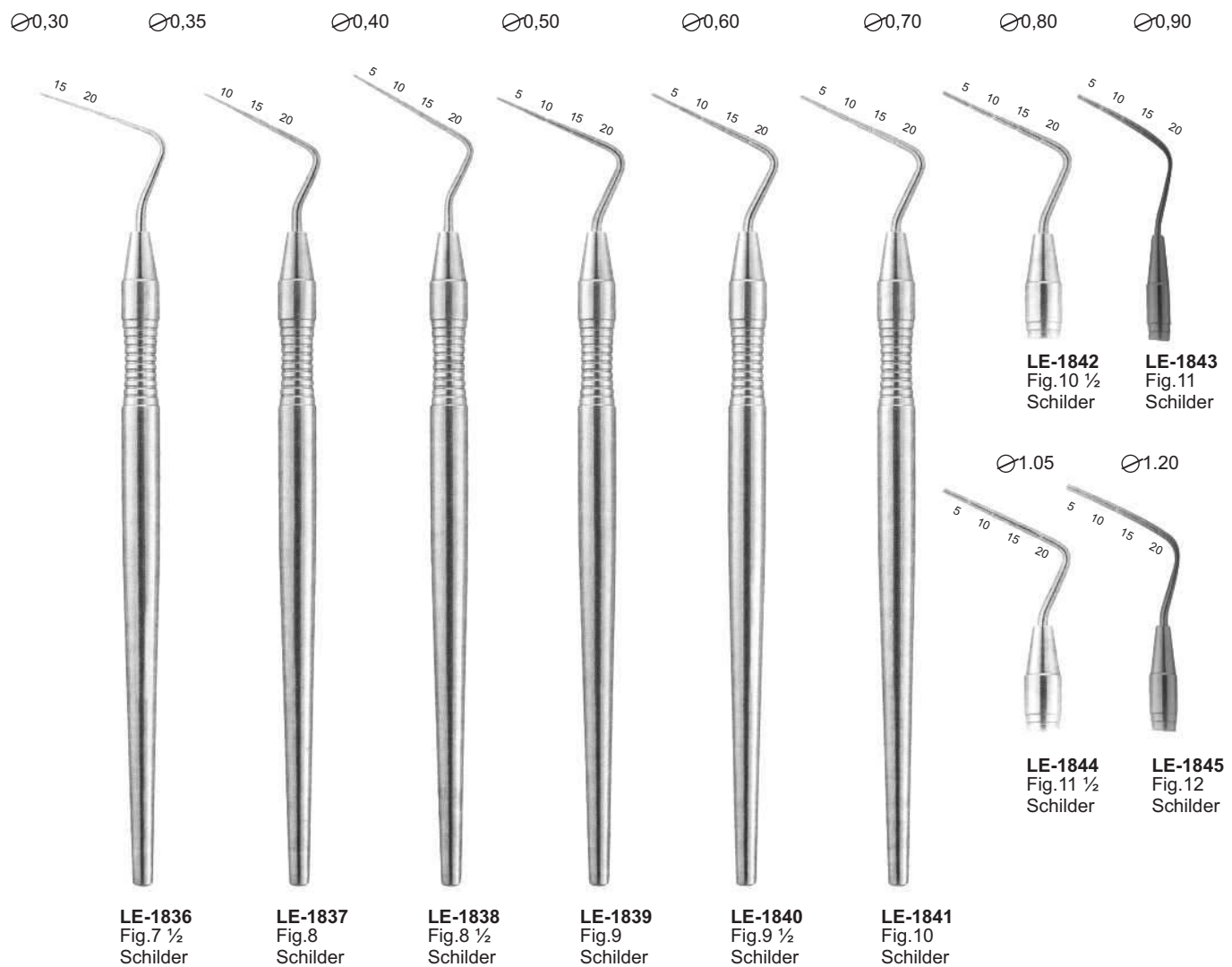

Root-canal explorers

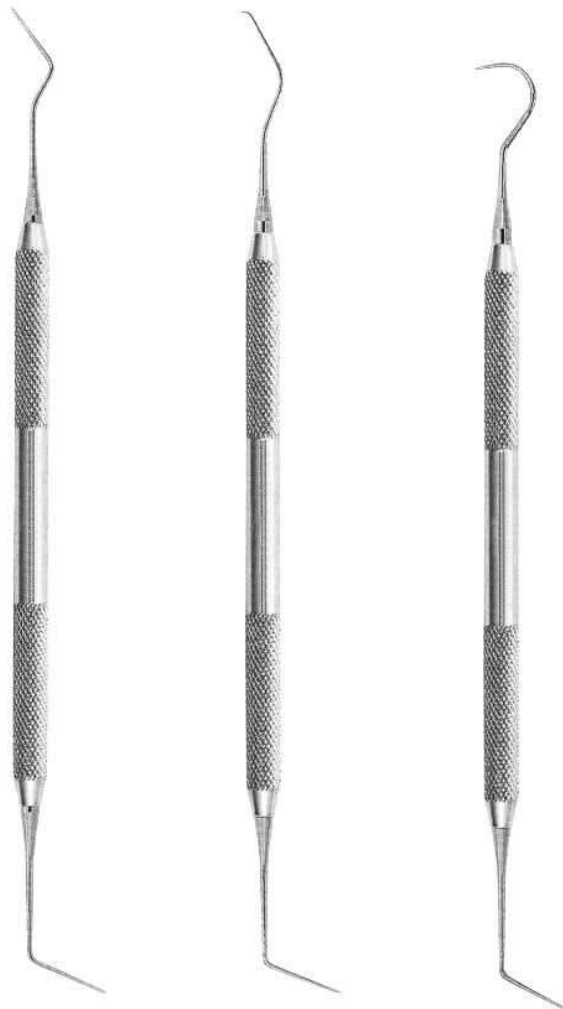

**LE-1846**  
Fig.6/1

**LE-1847**  
Fig.6/17

**LE-1848**  
Fig.6/23

Root-canal excavators

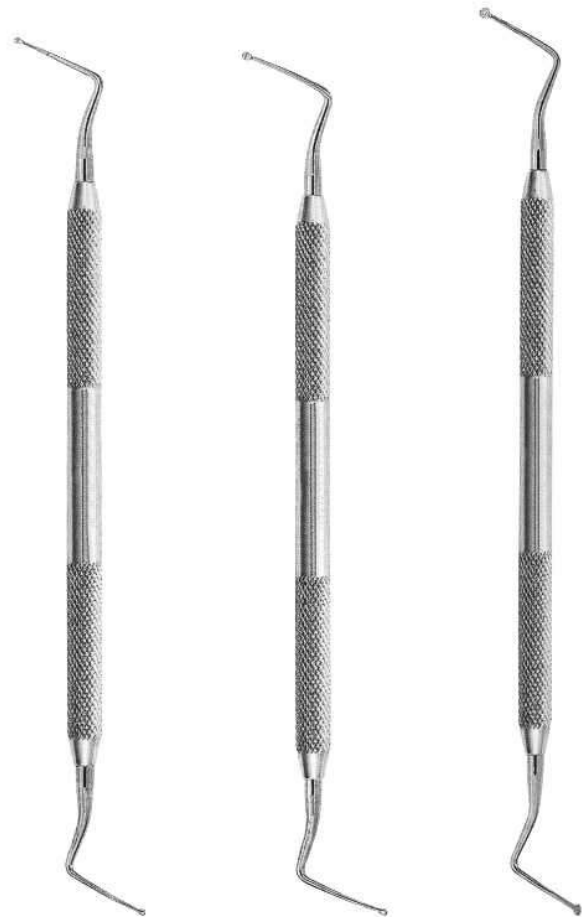

**LE-1849**  
Fig.31L

**LE-1850**  
Fig.32L

**1851**  
Fig.33L

1 mm



**LE-1852**  
Fig 5

1.2 mm



**LE-1853**  
Fig 14

1 mm



**LE-1854**  
Fig 17

1.2 mm



**LE-1855**  
Fig 18

1.6 mm



**LE-1856**  
Fig 19

2 mm



**1857**  
Fig 20

1 mm



**LE-1858**  
ASH  
Fig.243

1,4 mm



**LE-1859**  
ASH  
Fig.G2

0,8 mm



**LE-1860**  
Fig.1

0,8 mm



**LE-1861**  
Fig.2

1 mm



**LE-1862**  
Fig.11

1 mm



**LE-1863**  
Fig.12

1,2 mm



**1864**  
Fig.21

1,2 mm



**LE-1865**  
Fig.22

1,6 mm



**LE-1866**  
Fig.31

1,6 mm



**LE-1867**  
Fig.32

2 mm



**LE-1868**  
Fig.41

2 mm



**1869**  
Fig.42



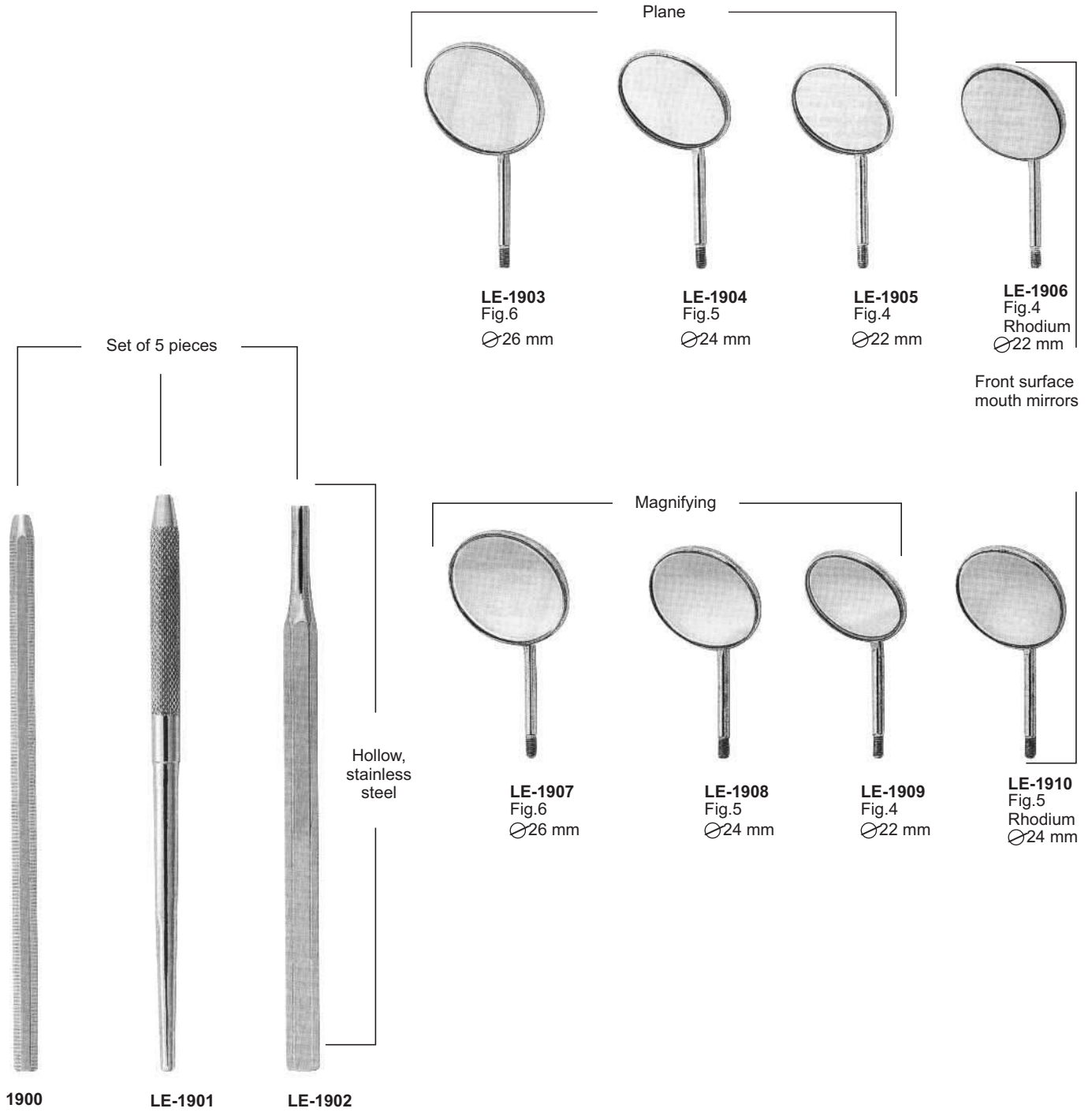



LE-1911



LE-1912



LE-1913



LE-1914



LE-1915



LE-1916  
Parallelometer  
mouth mirror

LE-1917  
Parallelometer  
mouth mirror  
+ handle  
code 2101

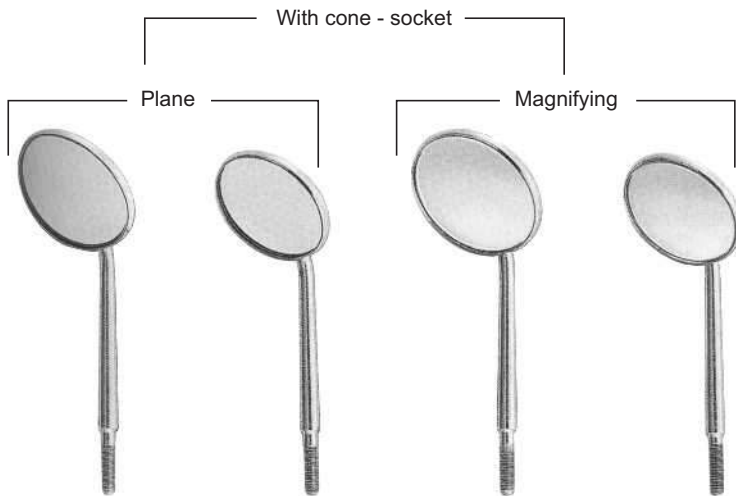

LE-1918  
Fig.5  
Ø24 mm

LE-1919  
Fig.4  
Ø22 mm

LE-1920  
Fig.5  
Ø24 mm

LE-1921  
Fig.4  
Ø22 mm



LE-1922  
Cone - socket



LE-1923  
Cone - socket



LE-1924  
Cone - socket



LE-2000



LE-2001



LE-2002

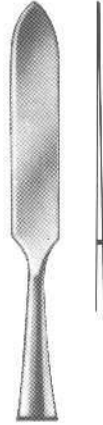

LE-2003

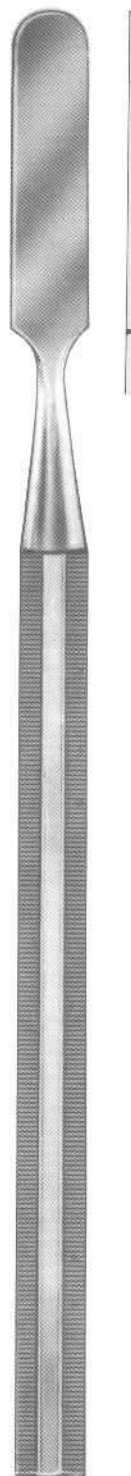

LE-2004



LE-2005

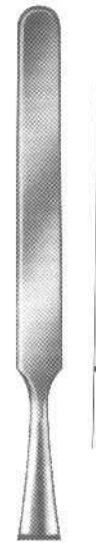

LE-2006



LE-2007

# Cement Spatulas

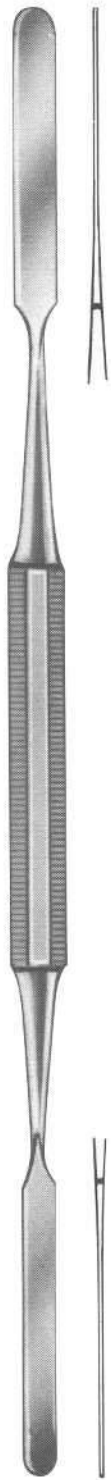

LE-2008

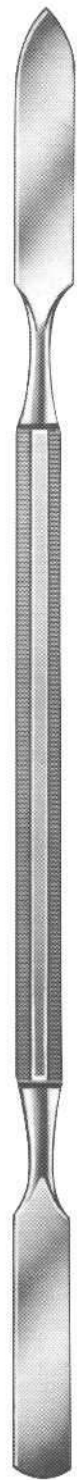

LE-2009



LE-2010

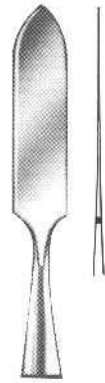

LE-2011



LE-2012



LE-2013

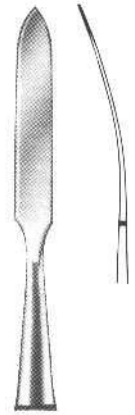

LE-2014

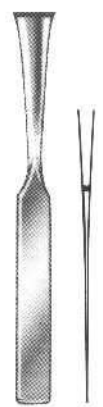







**LE-2200**  
Mayo-Hegar  
16 cm



**LE-2201**  
Mayo-Hegar TC  
16 cm



**LE-2202**  
Mayo-Hegar  
18 cm



**LE-2203**  
Mayo-Hegar TC  
18 cm



**LE-2204**  
Mini-Ryder  
18 cm



**LE-2205**  
Mini-Ryder TC  
15 cm



**LE-2206**  
Derf  
12 cm



**LE-2207**  
Hegar-Baumgarther  
14 cm



**LE-2208**  
Crile-Wood  
15 cm



**LE-2209**  
Crile-Wood TC  
15 cm

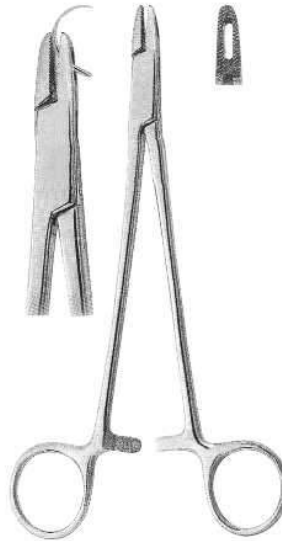

**LE-2210**  
Adson  
17.5 cm



**LE-2211**  
Olsen-Hegar  
14 cm



**LE-2212**  
Baumgarther  
14.5 cm



**LE-2213**  
Gillies  
16 cm



**LE-2214**  
Gillies  
16 cm



**LE-2215**  
Hegar-Baumgarther  
14 cm





**LE-2216**  
Toennis  
18 cm



**LE-2217**  
Toennis  
18 cm



**LE-2218**  
Lichtenberg  
17 cm



**LE-2219**  
Lichtenberg  
17 cm



**LE-2220**  
Eiselberg-Mathieu  
19.5 cm



**LE-2221**  
Boynton  
12 cm

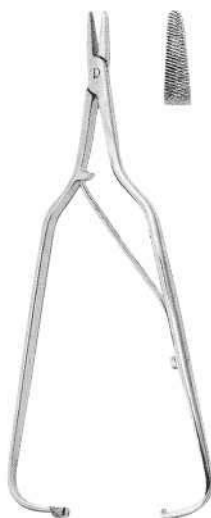

**LE-2222**  
Arruga  
16 cm



**LE-2223**  
Boynton  
12 cm



**LE-2224**  
Arruga  
16 cm



**LE-2225**  
Castroviejo  
14 cm



**LE-2226**  
Castroviejo  
14 cm



**LE-2227**  
Castroviejo  
14/60 cm

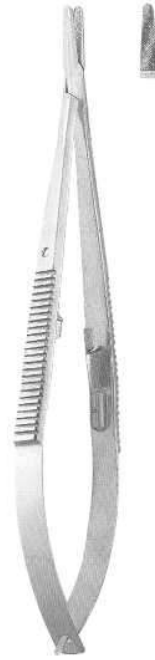

**LE-2228**  
Castroviejo  
18 cm



**LE-2229**  
Castroviejo  
18 cm



**LE-2230**  
Castroviejo  
14 cm

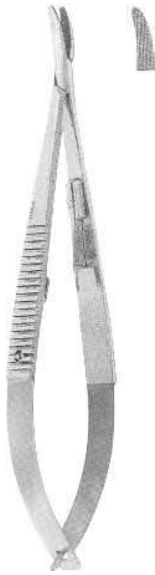

**LE-2231**  
Castroviejo  
14 cm

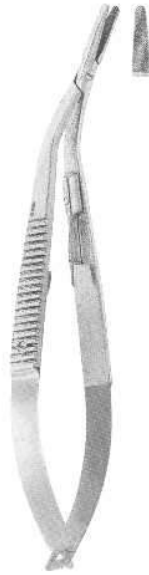

**LE-2232**  
Castroviejo  
14/60 cm



**LE-2233**  
Castroviejo  
18 cm



**LE-2234**  
Castroviejo  
18 cm

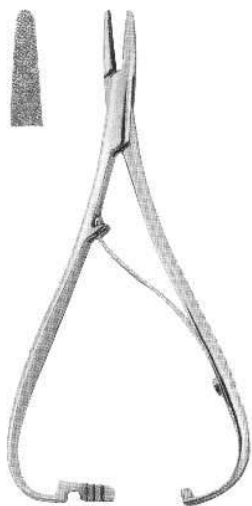

**LE-2235**  
Mathieu  
14 cm

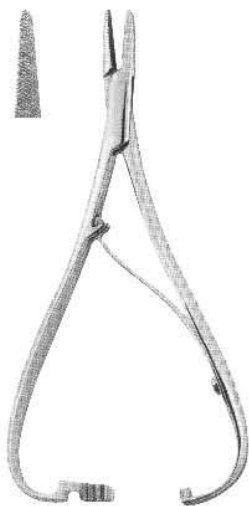

**LE-2236**  
Mathieu  
14 cm



**LE-2237**  
Mathieu  
14 cm

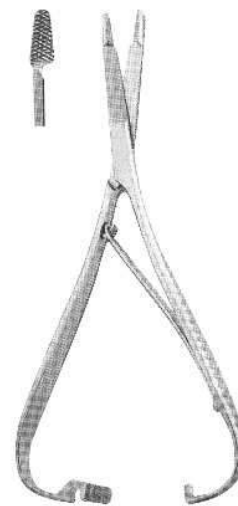

**LE-2238**  
Mathieu  
14 cm

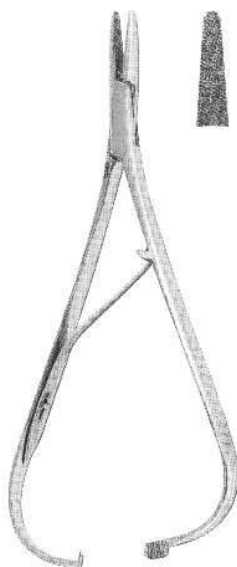

**LE-2239**  
Mathieu  
17 cm

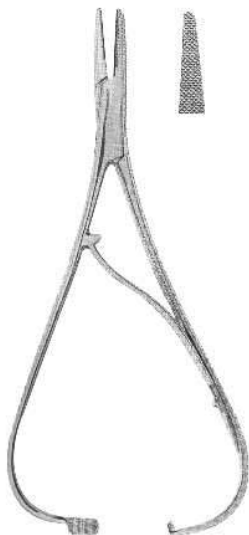

**LE-2240**  
Mathieu  
17 cm



**LE-2241**  
Mathieu  
14 cm

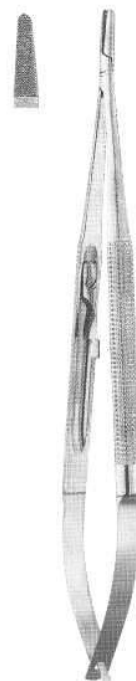

**LE-2242**  
Micro-Barraquer  
18 cm

# Needle Holders & Stainless Steel Saliva Ejectors



The tips have tungsten carbide inserts for better handling.



**LE-2243**  
Mathieu  
17 cm



**LE-2244**  
Mathieu  
17 cm



**LE-2245**  
Micro-Barraquer  
14 cm

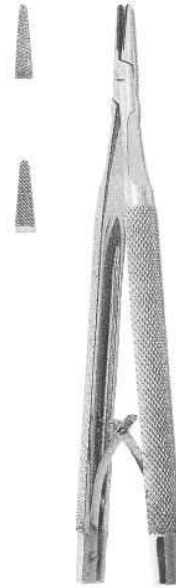

**LE-2246**  
Castroviejo  
13 cm



**LE-2247**  
Castroviejo-Barraquer  
13 cm



**LE-2248**  
Castroviejo  
13 cm



**LE-2249**  
Castroviejo  
13 cm



**LE-2251**  
18.03mm,cm



**LE-2252**  
18.04mm,cm



**LE-2253**  
18.05mm,cm



**LE-2250**  
Fig.6FR  
Fraizer  
15.02mm,cm



**LE-2254**  
Fig.12FR  
Fraizer  
15.04mm,cm



**LE-2255**  
Fig.10FR  
Fraizer  
15.03,3mm,cm



**2256**  
Fig.8FR  
Fraizer  
15.02,7mm,cm

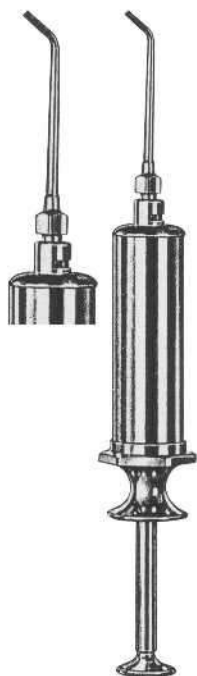

**LE-2300**  
Water Syringe complete with  
1 cannula (Lure-Lock)



**LE-2301**  
Water Syringe complete with  
1 cannula (Lure-Lock)



**LE-2302**  
Metal water syringe, self-filling,  
with 1 cannula (Lure-Lock)



**LE-2303**  
Sparrel Barrel with  
plunger suitable for  
syringes



**LE-2304**  
Cannula, only, with  
Luer-Lock connector  
suitable for syringes

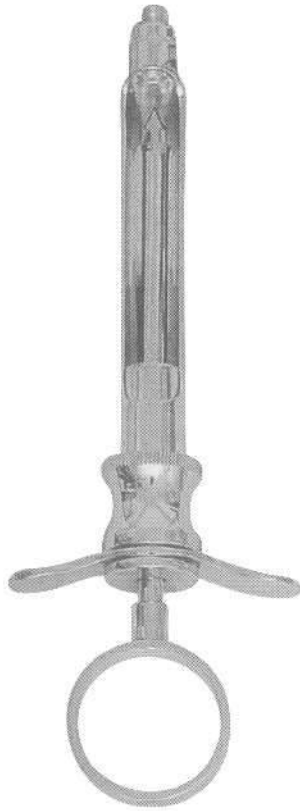

**LE-2305**  
Aspirating Syringe

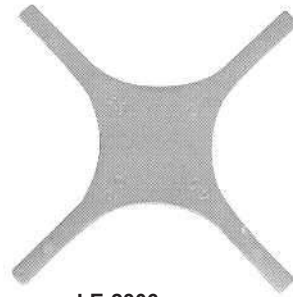

**LE-2306**  
Position Gauge

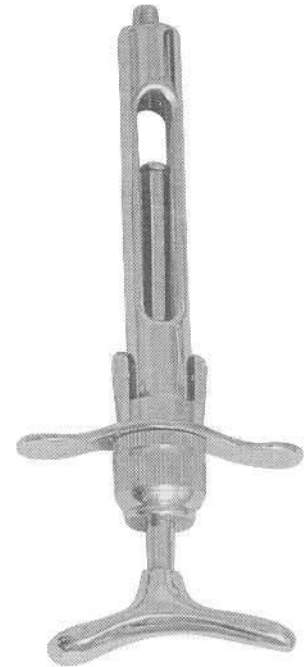

**LE-2307**  
Breech Loading Syringe

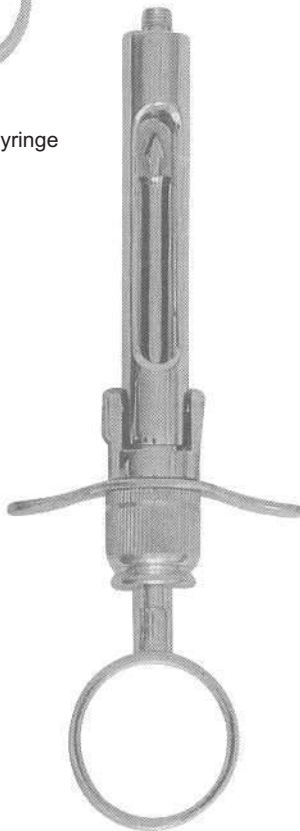

**LE-2308**  
Aspirating & Breech Syringe



**LE-2309**  
Band Adaptor



**LE-2310**  
Endo Finger Ruler  
With Adjustable Slide

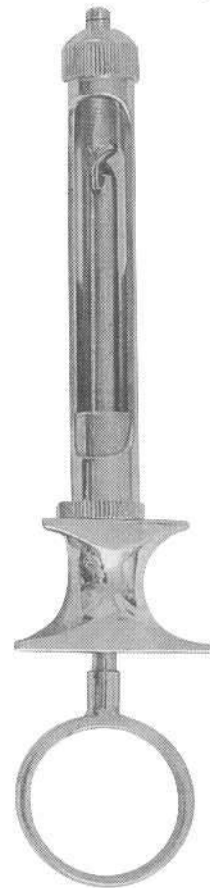

**LE-2311**  
Aspirating Syringe



LE-3701  
Bracket Gauge 0.18mm



LE-3702  
Bracket Gauge 0.22mm



LE-3703  
Micro Boley Gauge Straight ( Krekeler )



LE-3704  
Micro Boley Gauge Curved ( Krekeler )



**LE-3705**  
**Venus Apollo Gauge**



**LE-3706**  
**Locating Guide Pin Gauge SL**



**LE-3707**  
**Bracket Gauge Moveable Head**



**LE-3708**  
**Castroviejo Caliper 0-40mm**





LE-3709  
**Locating Guide Pin Gauge SS**



LE-3710  
**Duck Barren Gauge 80mm**



LE-3801  
**Scalpel Handle #3**



LE-3802  
**Scalpel Handle Moveable Head**



LE-2312



LE-2313



LE-2314

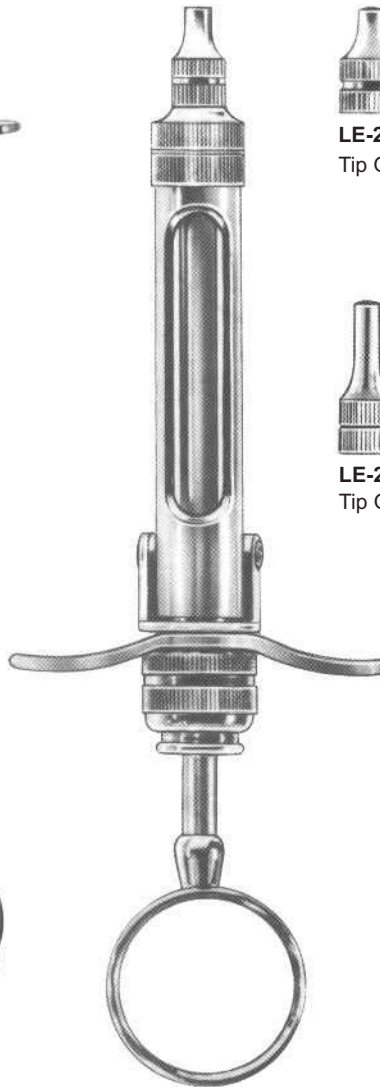

LE-2315 1,8 ml  
LE-2316 2,2 ml

Cartridge Syringe complete  
With 2 tips and without needles



LE-2317  
Tip Only, short



LE-2318  
Tip Only, long



LE-2319



LE-2320



LE-2321



**LE-3901**  
Aspirating Syringe 1.8ml BLUE



**LE-3902**  
Aspirating Syringe 1.8ml PINK (1)



**LE-3903**  
Intraligamental Syringe 1.8ml Curved Tip



**LE-3904**  
Ciotject Syringe 1.8ml Silver



LE-3905  
Ciotject Syringe 1.8ml Blue



LE-3906  
Intraligamental Syringe 1.8ml with Lock



**LE-2322**  
Cork screw tip



**LE-2323**  
Cork screw tip



**LE-2324**  
Folding type, cork screw tip



**LE-2325**  
Folding type, cork screw tip



**LE-2326**



**LE-2327**  
Cork screw tip



**LE-2328**  
Spare cap with metric thread



**LE-2329**  
With Whitworth thread



**LE-2330**  
Autoclavable Plastic Protection sleeve



**LE-2331**  
Brass syringe with stainless steel moving parts

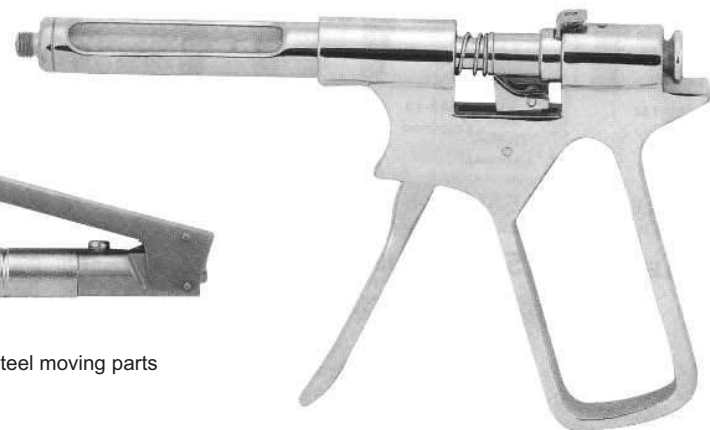

**LE-2332**  
Brass syringe with stainless steel moving parts

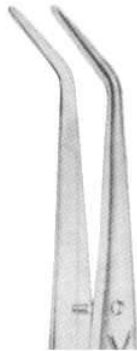

smooth

**LE-2400**  
College  
15 cm



serrated

**LE-2401**  
College  
15 cm



smooth

**LE-2402**  
College  
15 cm



serrated

**LE-2403**  
College  
15 cm



smooth

**LE-2404**  
College  
15 cm



serrated

**LE-2405**  
College  
15 cm



smooth

**LE-2406**  
College  
15 cm



serrated

**LE-2407**  
College  
15 cm

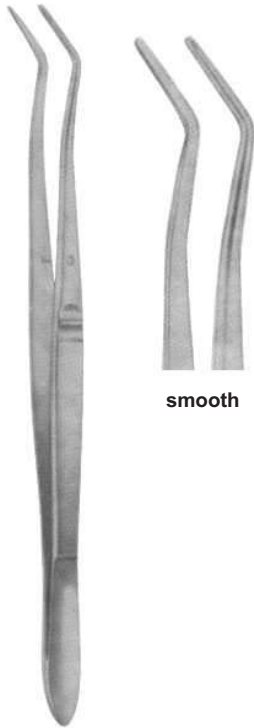

smooth

**LE-2408**  
Meriam  
16 cm

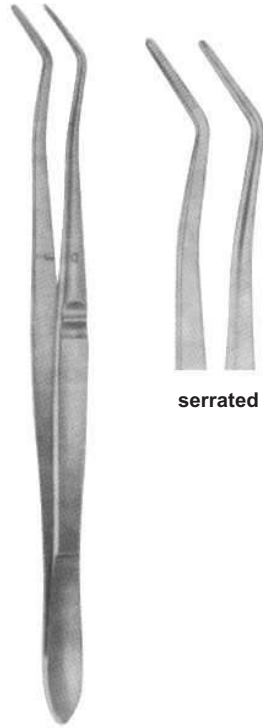

serrated

**LE-2409**  
Meriam  
16 cm

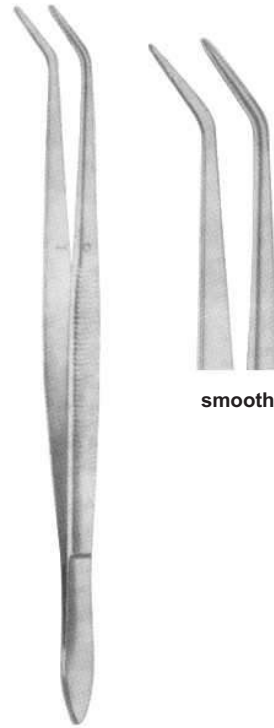

smooth

**LE-2410**  
Meriam  
16 cm

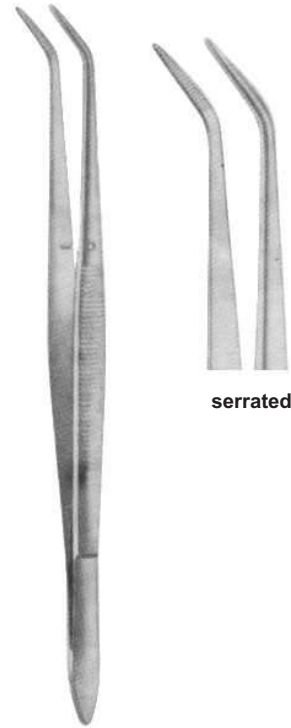

serrated

**LE-2411**  
Meriam  
16 cm

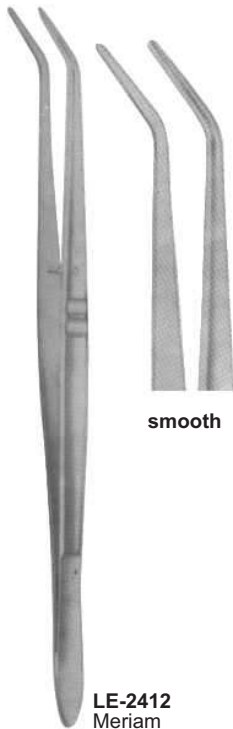

smooth

**LE-2412**  
Meriam  
16 cm

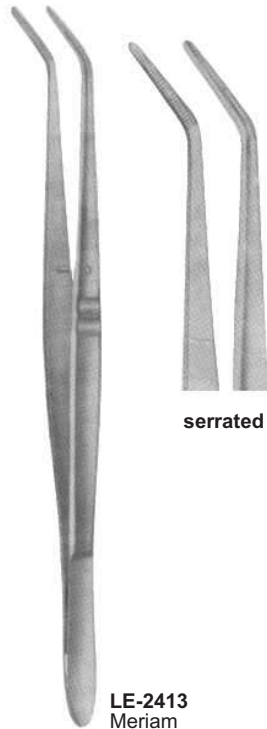

serrated

**LE-2413**  
Meriam  
16 cm

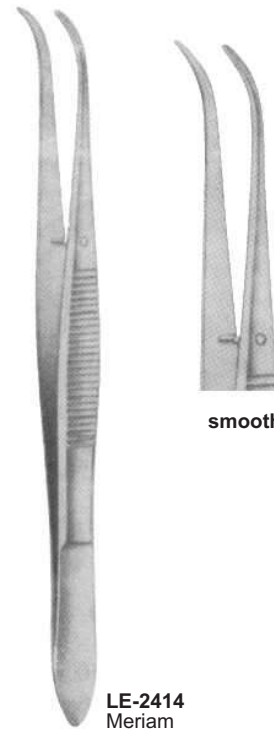

smooth

**LE-2414**  
Meriam  
16 cm

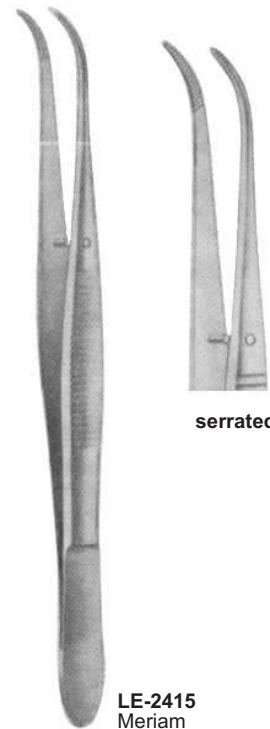

serrated

**LE-2415**  
Meriam  
16 cm



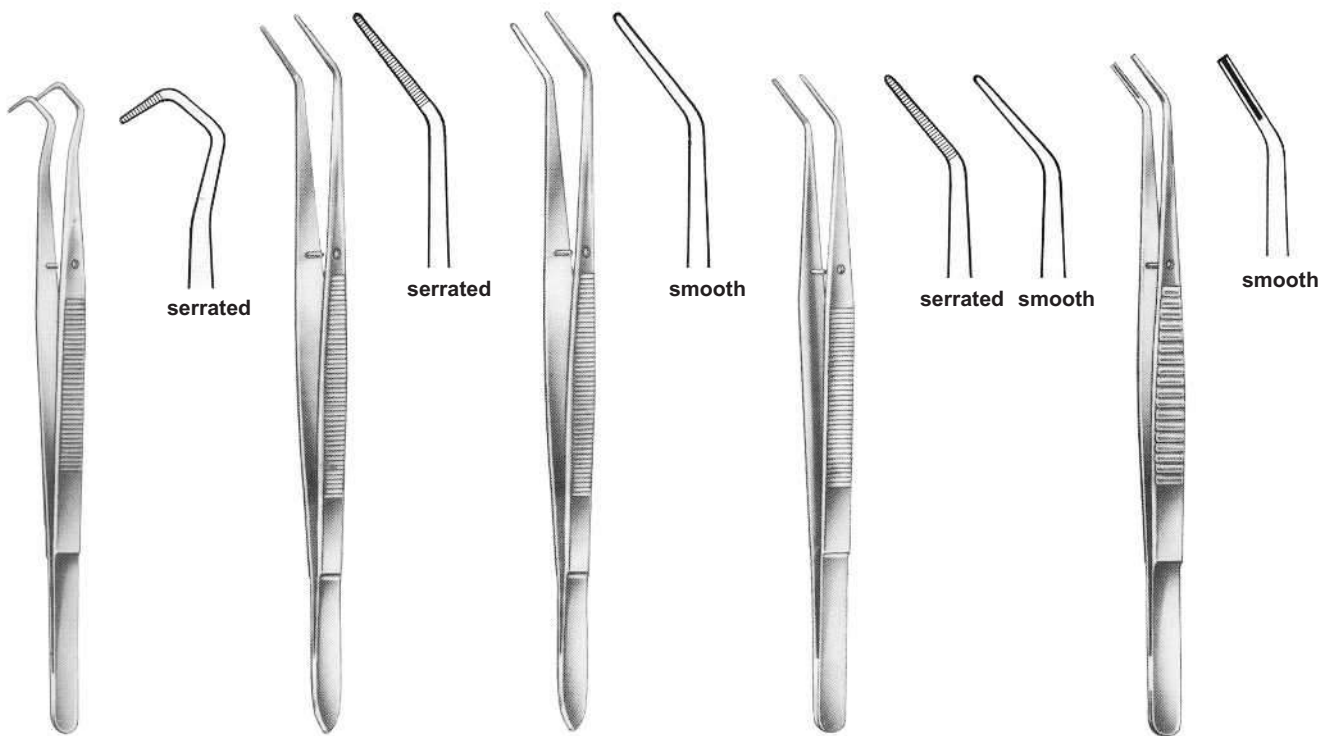

**LE-2416**  
College  
14.5 cm, 5<sup>3</sup>/<sub>4</sub>"

**LE-2417**  
Flagg  
16 cm, 6<sup>1</sup>/<sub>4</sub>"

**LE-2418**  
Flagg  
16 cm, 6<sup>1</sup>/<sub>4</sub>"

**LE-2419**  
Landgraf  
15 cm, 6"

**LE-2420**  
15.5 cm, 6<sup>1</sup>/<sub>8</sub>"

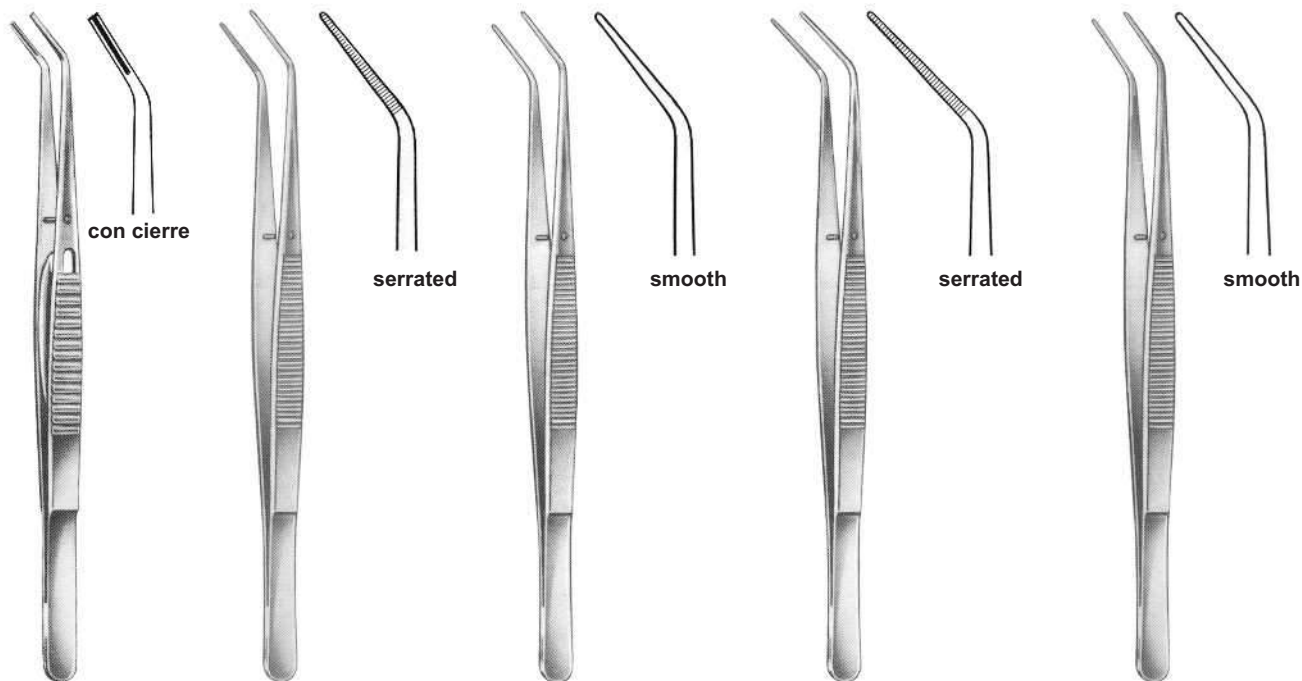

**LE-2421**  
15.5 cm, 6<sup>1</sup>/<sub>8</sub>"

**LE-2422**  
London-College  
15 cm, 6"

**LE-2423**  
London-College  
15 cm, 6"

**LE-2424**  
London-College  
15 cm, 6"

**LE-2425**  
London-College  
15 cm, 6"



**LE-2426**  
CK1  
15 cm, 6"

**LE-2427**  
CK2  
15 cm, 6"

**LE-2428**  
GF2  
16 cm, 6 1/4"

**LE-2429**  
Gf1  
16 cm, 6 1/4"

**LE-2430**  
Kopp  
15.5 cm, 6 1/8"

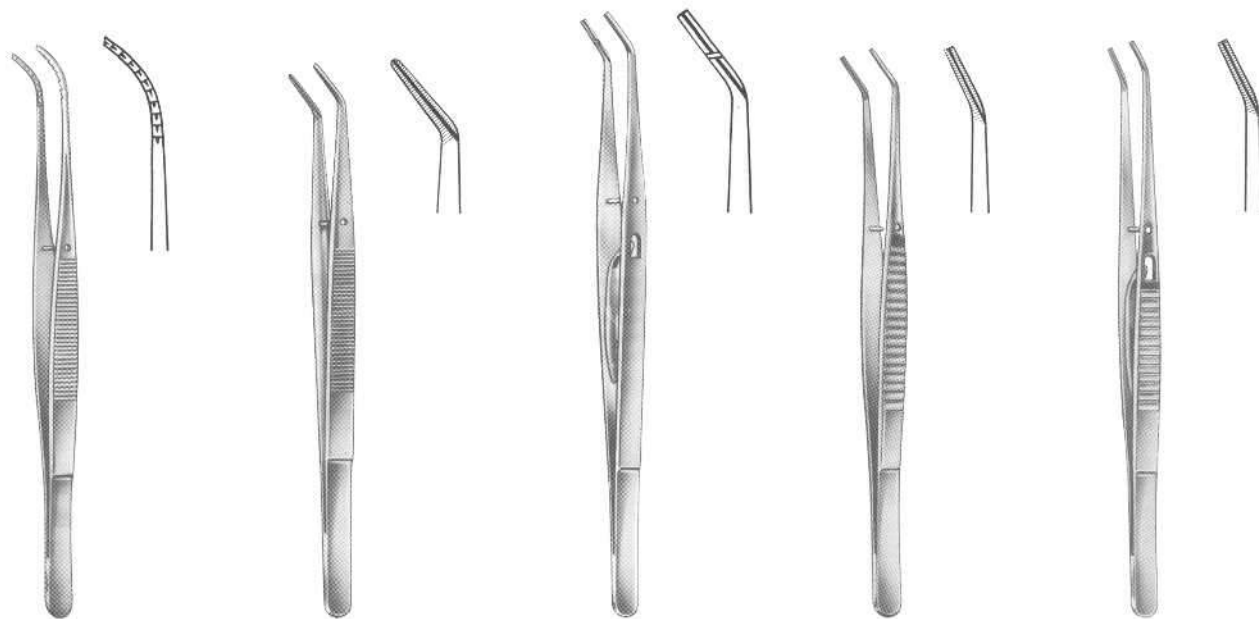

**LE-2431**  
Kopp  
15.5 cm, 6 1/8"

**LE-2432**  
15 cm, 6"

**LE-2433**  
16.5 cm, 6 1/2"

**LE-2434**  
15.5 cm, 6 1/8"

**LE-2435**  
15.5 cm, 6 1/8"



**LE-2436**  
London-College  
15 cm, 6"

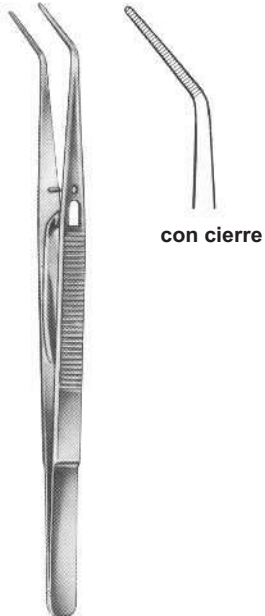

**LE-2437**  
London-College  
15 cm, 6"

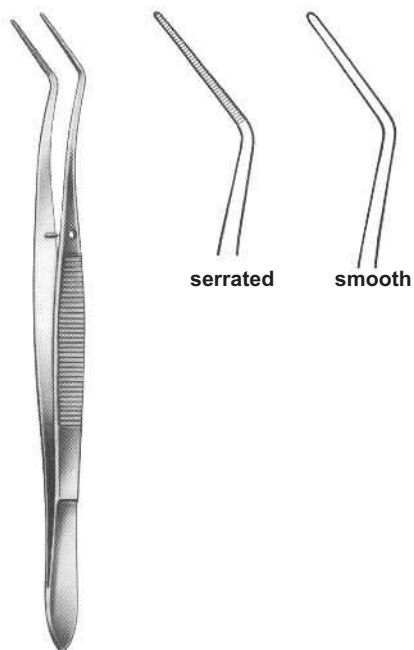

**LE-2438**  
Meriam  
16 cm, 6 1/4"

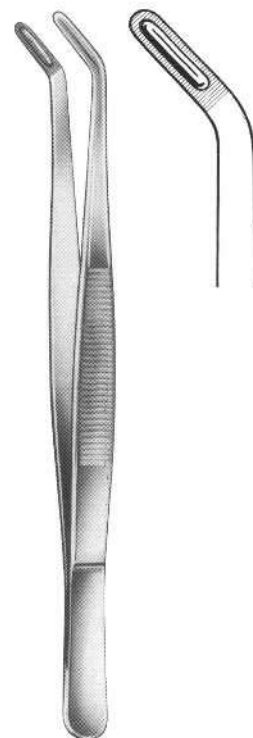

**LE-2439**  
Allen  
18 cm, 7 1/8"

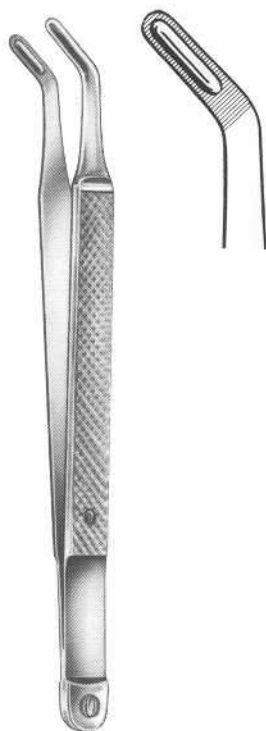

**LE-2440**  
Albrecht  
16 cm, 6 1/4"

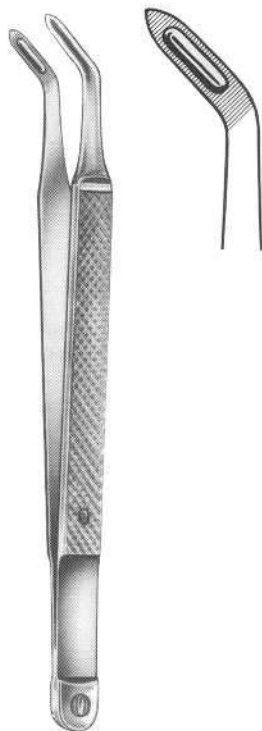

**LE-2441**  
Albrecht  
16 cm, 6 1/4"

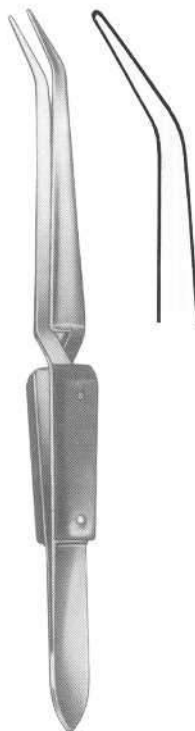

**LE-2442**  
16 cm, 6 1/4"

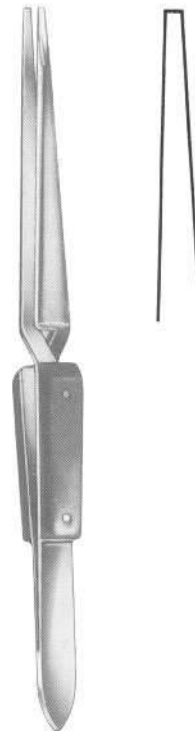

**LE-2443**  
16 cm, 6 1/4"



**LE-2444**  
16 cm, 6 1/4"



**LE-4001**  
**Adson Kocher Tweezer**



**LE-4002**  
**Corn Suture Tweezer**



**LE-4003**  
**De Backey Tweezer**



**LE-4004**  
**Mini Dressing Tweezers**



**LE-4005**  
**Self Lock Tweezers**



**LE-4006**  
**Adson 15cm**



**LE-4007**  
**Adson Brown Curved**



**LE-4008**  
**Adson 15cm**



**LE-4009**  
**Adson Needle Tweezer**



**LE-4010  
Adson Brown Straight**



**LE-4011  
Dressing Tweezer**



**LE-4012  
Dressing Kocher**



**LE-1002**  
Iris  
115mm  
Straight



**LE-1003**  
Iris  
115mm  
Curved



**LE-1004**  
Goldman-Fox  
130mm  
Saw edge, straight



**LE-1005**  
Goldman-Fox  
130mm  
Saw edge, curved



**LE-1006**  
La Grange  
115mm  
Saw edge, double curve



Mayo  
**LE-1007** 140mm  
**LE-1008** 170mm  
**LE-1009** 230mm  
Straight



Mayo  
**LE-1010** 140mm  
**LE-1011** 170mm  
**LE-1012** 230mm  
Curved



Metzenbaum  
**LE-1013** 140mm  
**LE-1014** 180mm  
**LE-1015** 200mm  
Straight



Metzenbaum  
**LE-1016** 140mm  
**LE-1017** 180mm  
**LE-1018** 200mm  
Curved



**LE-1019**  
Kelly  
160mm  
Straight



**LE-1020**  
Kelly  
160mm  
Curved



**LE-1021**  
Iris  
115mm  
Straight



**LE-1022**  
Iris  
115mm  
Curved



**LE-1023**  
La Grange  
115mm  
Double Curved



**LE-1024**  
Goldman-Fox  
130mm  
Straight



**LE-1025**  
Goldman-Fox  
130mm  
Curved



**LE-1026**  
Kelly  
160mm  
Curved



**LE-1027**  
Iris  
115mm  
Straight



**LE-1028**  
Iris  
115mm  
Curved



**LE-1029**  
Micro Iris  
90mm  
Curved

# GUM SCISSORS



**LE-1030**  
Iris  
115mm  
Angled

**LE-1031**  
Iris  
115mm  
Curved

**LE-1032**  
Goldman-Fox  
130mm  
Saw edge,  
straight

**LE-1033**  
Goldman-Fox  
130mm  
Saw edge,  
curved

**LE-1034**  
Goldman-Fox  
130mm  
Saw edge,  
curved

**LE-1035**  
La Grange  
115mm  
Saw edge,  
double  
curved

**LE-1036**  
Neumann  
120mm  
Saw edge,  
double  
curved



**LE-1037**  
Kilner  
120mm  
Straight

**LE-1038**  
Kilner  
120mm  
Curved

**LE-1039**  
Joseph  
140mm  
Straight

**LE-1040**  
Joseph  
140mm  
Curved

**LE-1041**  
Kelly  
160mm  
Straight

**LE-1042**  
Kelly  
160mm  
Straight

**LE-1043**  
Locklin  
160mm  
Saw edge  
angular

**LE-1044**  
Locklin  
120mm  
160mm  
Saw edge  
angular

**LE-1045**  
Dean  
170mm  
Saw edge  
angular



**LE-1046**  
Spencer  
90mm

**LE-1047**  
Spencer  
130mm

**LE-1048**  
Spencer  
115mm

**LE-1049**  
Noyes  
110mm, straight

**LE-1150**  
Noyes  
110mm,  
curved

**LE-1151**  
Noyes  
110mm,  
Angular

**LE-1152**  
Castroviej  
150mm,  
curved



**LE-1053**  
130mm  
Straight



Mayo  
**LE-1054** 130mm  
**LE-1055** 160mm  
**LE-1056** 280mm  
Straigh Curved



Mayo  
**LE-1057** 140mm  
**LE-1058** 200mm  
Straigh Curved



Metzenbaun  
**LE-1059** 145mm  
**LE-1060** 200mm  
Straigh Curved



**LE-1061**  
Beebee  
110mm  
Saw edge  
straight



**LE-1062**  
Beebee  
110mm  
Saw edge  
curved



**LE-1063**  
Beebee  
110mm  
Saw edge  
straight



**LE-1064**  
Beebee  
110mm  
Saw edge  
curved

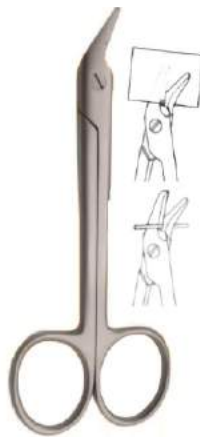

**LE-1065**  
Universal  
120mm  
Saw edge



**LE-1066**  
Universal  
120mm



Crile  
**LE-1067** 130mm  
**LE-1068** 150mm  
**LE-1069** 180mm



**LE-1070**  
Halsey  
130mm



**LE-1071**  
Baumgarter  
130mm



**LE-1072**  
Derf  
120



**LE-1073**  
Delicate  
150mm



Mayo-Hegar  
**LE-1074** 130mm  
**LE-1075** 160mm  
**LE-1076** 180mm  
**LE-1077** 200mm



**LE-1078**  
Crile-wood  
150mm  
straight



**LE-1079**  
Crile-wood  
150mm  
Curved



# NEEDLE HOLDER



Castroveijo  
**LE-1080** 130mm  
**LE-1081** 150mm  
**LE-1082** 180mm



**LE-1083**  
 Halsey  
 130mm



**LE-1084**  
 Baumgartner  
 130mm



**LE-1085**  
 Derf  
 120mm



**LE-1086**  
 Delicate  
 150mm



**LE-1087**  
 Adson  
 170mm



Mayo-Hegar  
**LE-1088** 130mm  
**LE-1089** 150mm  
**LE-1090** 180mm  
**LE-1091** 200mm



**LE-1092**  
 Crile wood  
 150mm



Castroveijo  
**LE-1093** str 140mm cvd  
**LE-1094** str 180mm cvd



Olsen-Hegar Needle  
 Holder with scissors  
**LE-1095** 140mm



Gillies Needle  
 Holder with scissors  
**LE-1096** 160mm



Mathieu  
**LE-1097** 140mm  
**LE-1098** 180mm



Castroveijo  
**LE-1099** str 140mm cvd  
**LE-1100** str 180mm cvd



Olsen-Hegar Needle  
 Holder with scissors  
**LE-1101** 140mm



Gillies Needle  
 Holder with scissors  
**LE-1102** 160mm



Hartmann Baby Mosquito  
**LE-1103** 90mm straight



Halstrad Mosquito  
**LE-1105** 125mm straight

**LE-1104**  
 125mm  
 Curved

**LE-1106**  
 Curved

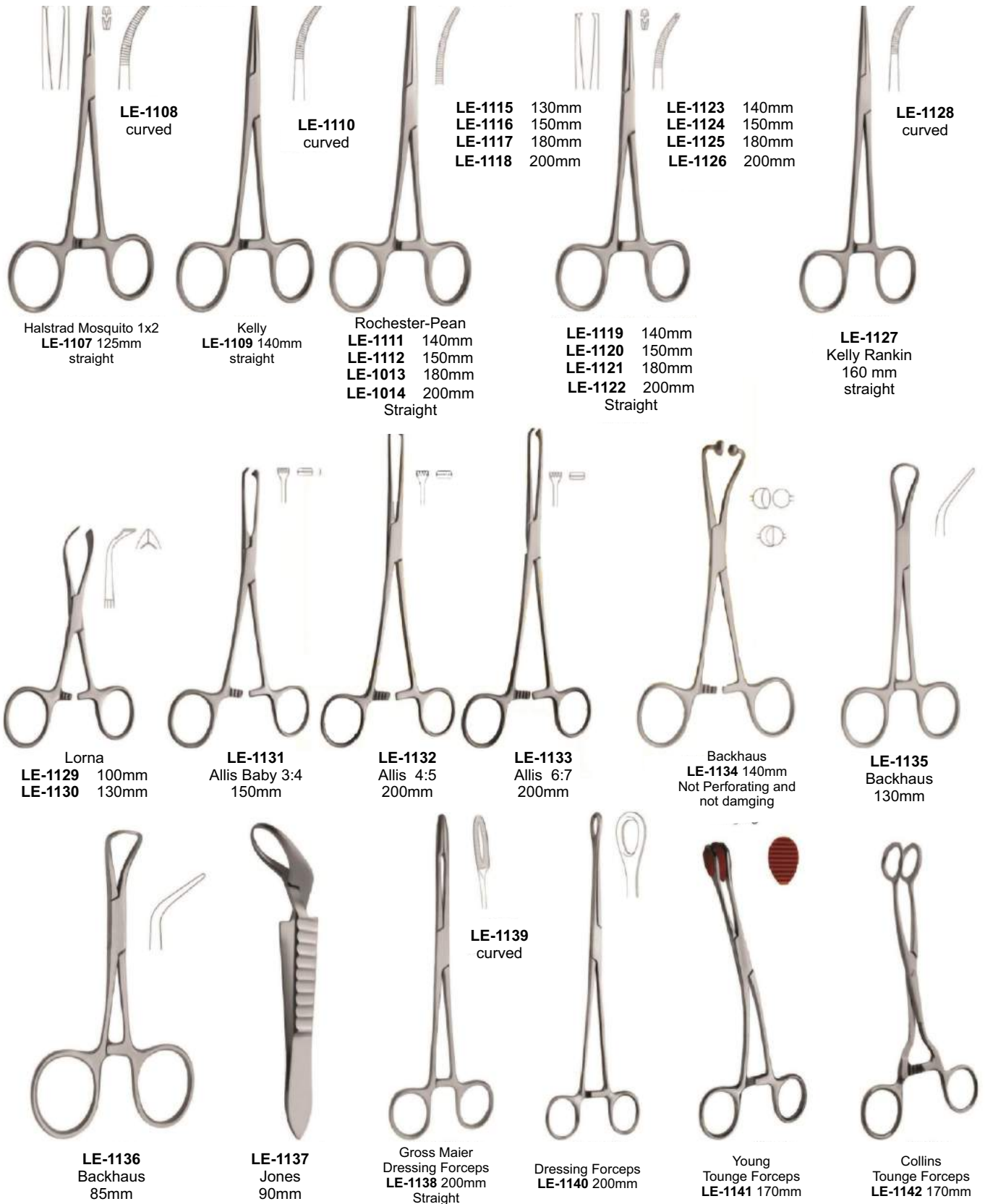

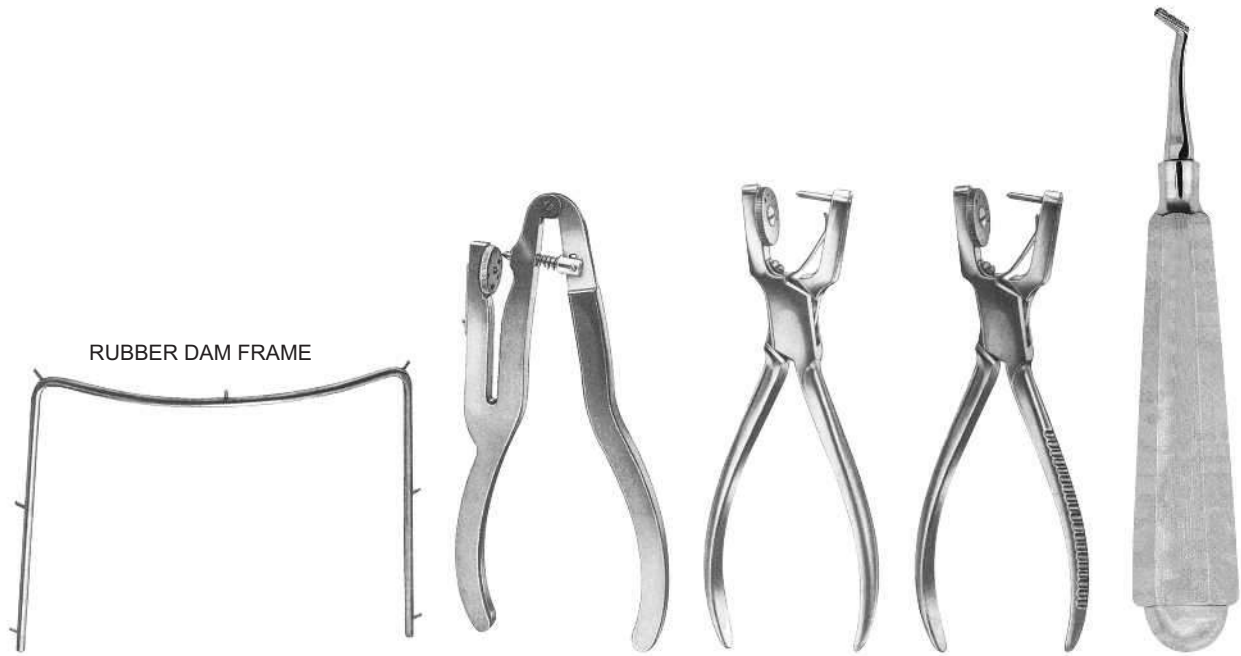

RUBBER DAM FRAME

**LE-2500**  
Young  
105x95 Inox

**LE-2501**  
Ivory  
160 mm

**LE-2502**  
Ainsworth  
170 mm

**LE-2503**  
Ainsworth  
170 mm

**LE-2504**  
Mershan  
140 mm

## CLAMPS ( PLIERS )

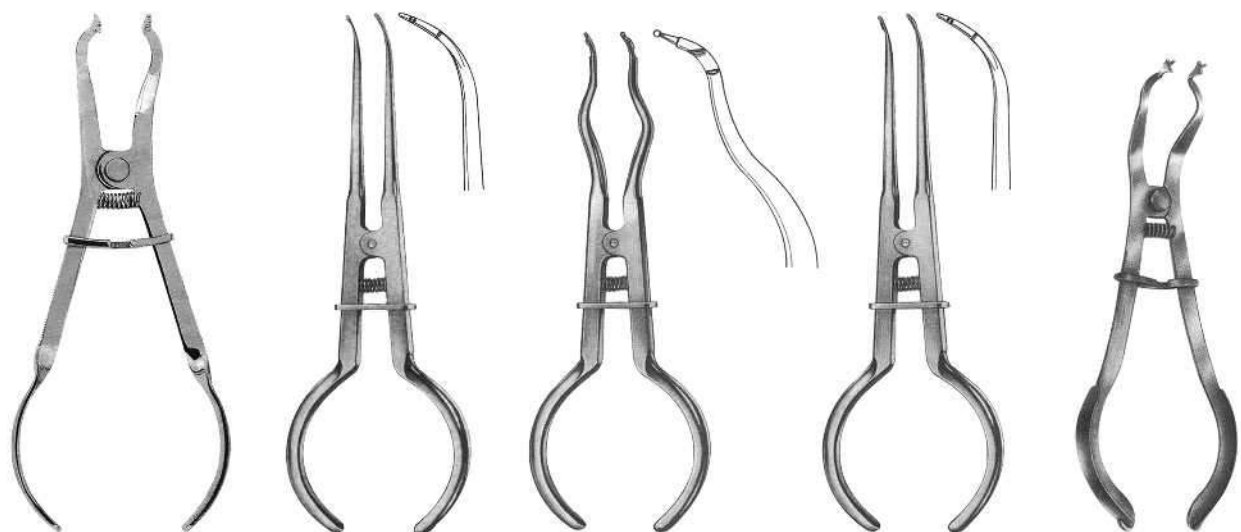

**LE-2505**  
Ivory light weight  
170 mm

**LE-2506**  
Brewer  
175 mm

**LE-2507**  
Brewer  
175 mm

**LE-2508**  
White  
175 mm

**LE-2509**  
Ivory  
170 mm

**Anterior**

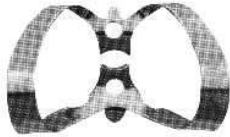

**LE-2510**  
Winged  
Labial Clamp

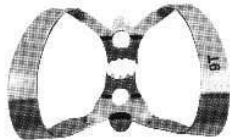

**LE-2511**  
Winged  
Edged Labial Clamp

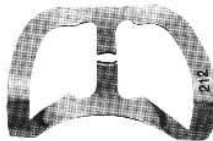

**LE-2512**  
Winged  
Cervical Clamp



**LE-2513**  
Winged  
Labial Clamp

**Premolars**



**LE-2514 - 00**  
Winged



**LE-2515 0**  
Winged



**LE-2516 - WO**  
Wingless

For Small Teeth, Elongated or With Narrow Collars

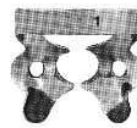

**LE-2517 - 1**  
Winged



**LE-2518**  
Winged



**LE-2519**  
Wingless

For General Use With Adjustable Jaws According  
To Gingival Line Shapes



**LE-2520**  
Winged



**LE-2521**  
Edged, Winged



**LE-2522**  
Wingless

For Premolars, With Elongated Collar



**LE-2523**  
Winged

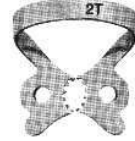

**LE-2524**  
Edged, Winged



**LE-2525**  
Wingless

For Premolars, With Elongated Collar



**LE-2526**  
Wingless



**LE-2527**  
Wingless

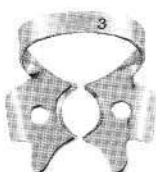

**LE-2528 - 3**  
Winged



**LE-2529**  
Wingless

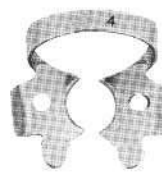

**LE-2530**  
Winged



**LE-2531**  
Wingless

**For Small Lower Molars**

**For Small Lower Molars With Round clamps**



**LE-2532 - 7**  
Winged

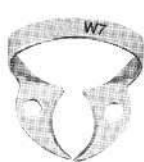

**LE-2533**  
Wingless

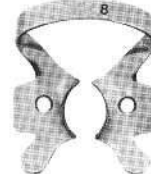

**LE-2534 - 8**  
Winged

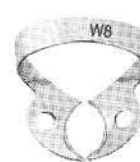

**LE-2535**  
Wingless

**For Square Lower Molars**

**For Round Upper Molars**

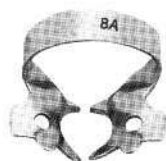

**LE-2536 - 8A**  
Winged



**LE-2537**  
Wingless



**LE-2538**  
Winged

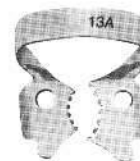

**LE-2539**  
Wingless

**For Molar Roots**

**For Partially Broken Molars**



**LE-2540**  
Winged

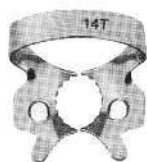

**LE-2541**  
Edged Winged



**LE-2542**  
Wingless



**LE-2543**  
Winged



**LE-2544**  
Wingless

**For Round Molars, Partially Broken, Undersized or Inclined**



**LE-2545**  
Wingless



**LE-2246**  
Wingless



**LE-2547**  
Winged

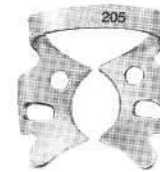

**LE-2548**  
Winged



LE-2549  
Clamps Set of 32



LE-2550  
Clamps Set of 5 Wingless

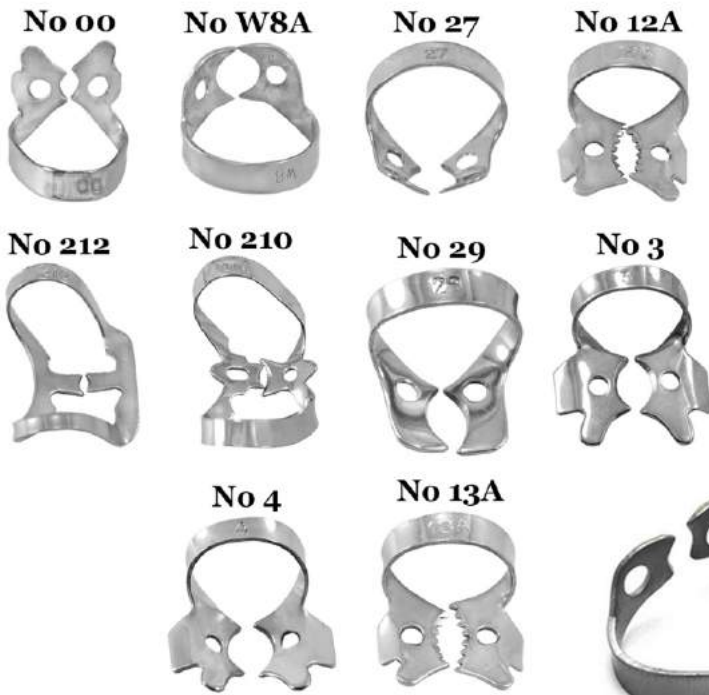

LE-2551  
Clamps Set of 10



LE-2552  
Clamps Tray



LE-6004  
Rubber Clamp B4



LE-2553  
Brinker Clamps Set of 6



LE-2554  
Clamps Set of 8



LE-5555  
Stoke



LE-4101  
Mosquito Straight



LE-4102  
Mosquito Curved



LE-4103  
Bengolia Artery Forceps



# Matrix Retainers and Matrix Bands



**2600**  
Ivory  
63mm



**LE-2601-1**  
Tofflemire-Universal



**LE-2602**  
Tofflemire-Junior



**LE-2603-3**  
Tofflemire-Senior



**LE-2604**  
Ivory 8  
5 mm



**LE-2605**  
Ivory 8  
6 mm



**LE-2606**  
Ivory 8  
7 mm



**LE-2607**  
Ivory 8 N



**LE-2608**  
Didner 8 P



**LE-2610-7**



**LE-2611-8**



**LE-2612-9**

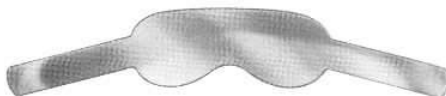

**LE-2613-10**

For Molars and Premolars



**LE-2614-11**

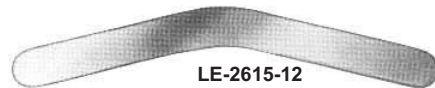

**LE-2615-12**

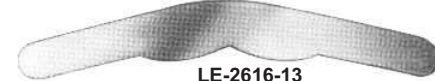

**LE-2616-13**

LE-1750-5 mm x 100 cm  
LE-1750-6 mm x 100 cm  
LE-1750-7 mm x 100 cm



**2609**



LE-2617  
 Molar  
 Fig 7



LE-2618  
 Molar  
 Fig 8

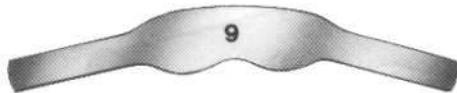

LE-2619  
 Molar  
 Fig 9

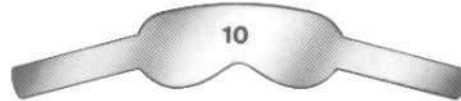

LE-2620  
 Molar  
 Fig 10



LE-2621  
 Tofflemire



LE-2622  
 Tofflemire



LE-2623  
 Tofflemire



LE-2624  
 Bicuspids



LE-2625  
 Bicuspids



LE-2626  
 Bicuspids



LE-2627  
 Bicuspids



LE-2628  
 Bicuspids



LE-2629  
 Bicuspids



LE-2633



LE-2630  
 Molar



LE-2631  
 Molar



LE-2632  
 Molars

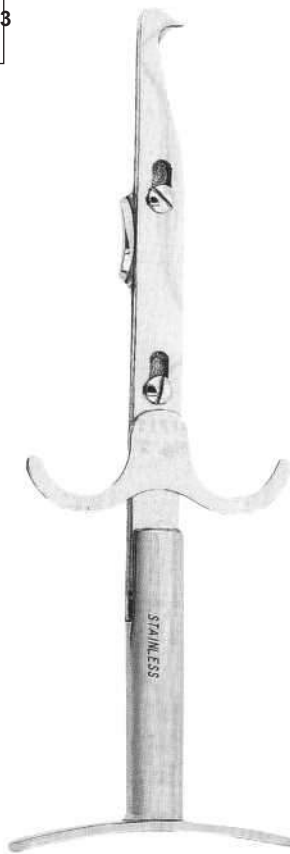
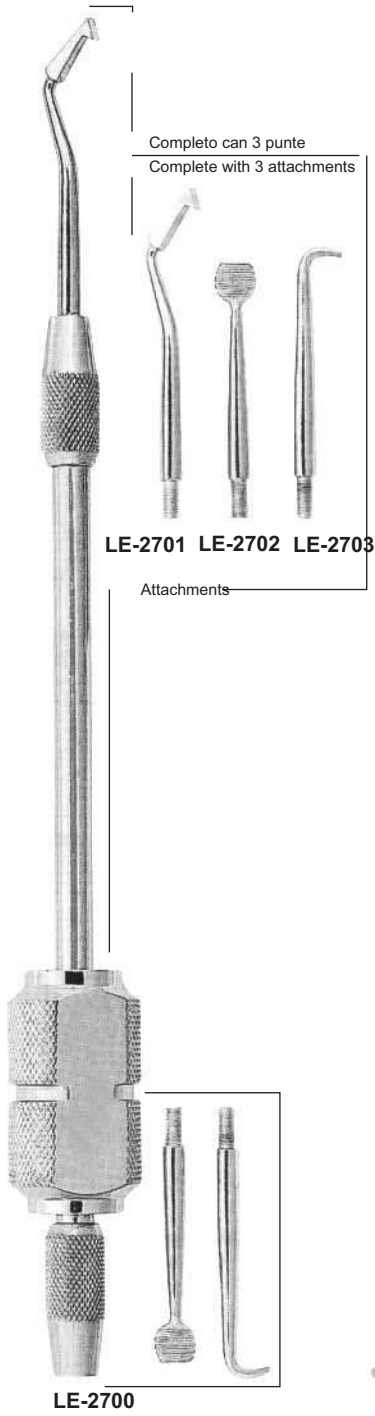

**LE-2704**  
Crown Spreader, Crown Remove.  
Special instrument for crown spreading  
after separating, simple and safe  
operation.





Universal "HM"  
12 cm, 4 3/4"



LE-2709

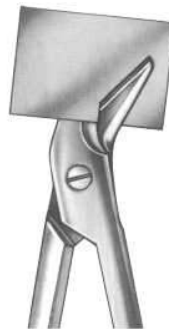

LE-2710



LE-2711  
Beebee  
10,5 cm, 4 1/8"



LE-2712  
Mershon



LE-2713  
Morell



LE-2714  
Morell



LE-2715  
Morell



LE-2716  
Morell



LE-2717  
Treymann



LE-2718  
Automatic Crown Remover  
With 2 Points



LE-2719



LE-2720

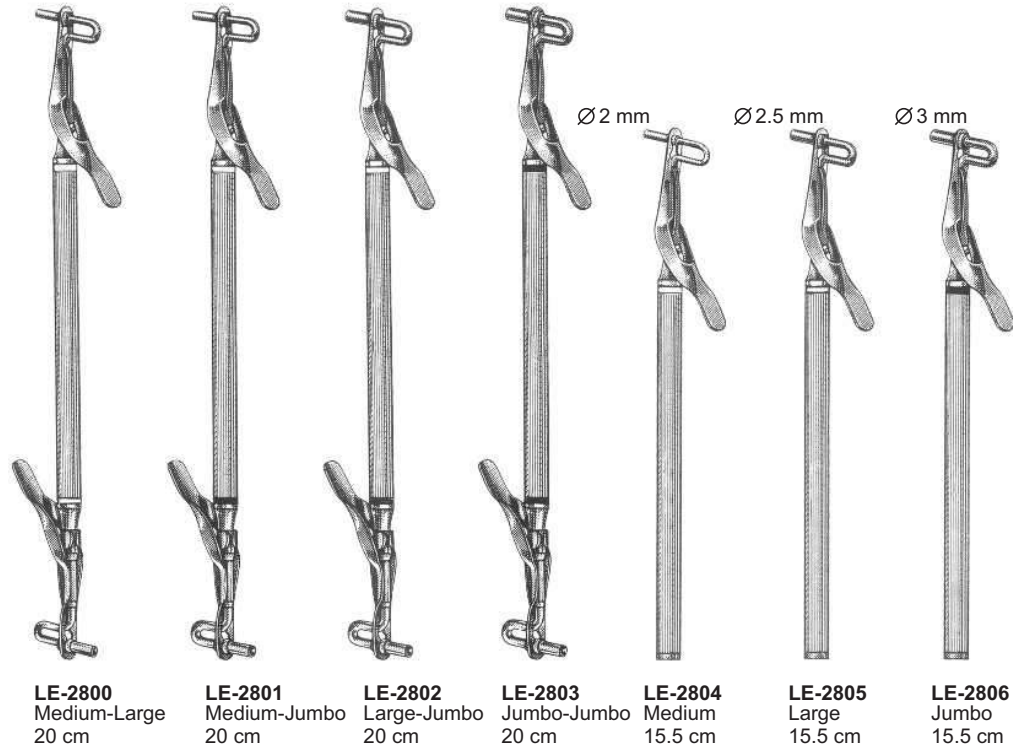

Copper ring removing pliers



**LE-2900**  
Bohm  
11,5 cm



**LE-2901**  
Bohm  
14,5 cm



**LE-2902**  
Furrer  
16 cm



**LE-2903**  
Furrer  
16 cm



**LE-2904**  
Miller  
15 cm



**LE-2905**  
Miller  
15 cm



**LE-2906**  
Kelly  
14 cm



**LE-2907**  
Halstead-Mosquito  
12 cm



**LE-2908**  
Micro-Mosquito  
10 cm

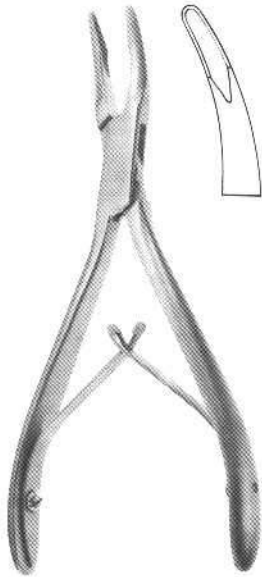

**LE-3000**  
Friedmann  
14 cm, 5 1/2"

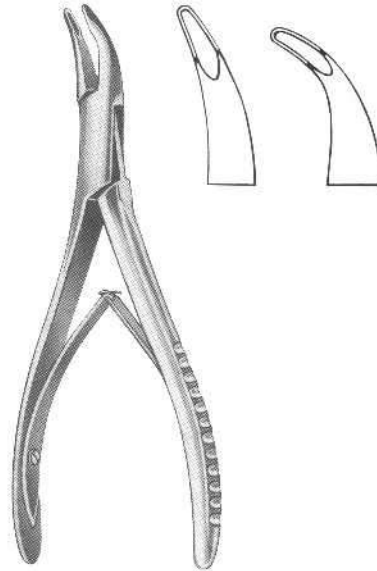

**LE-3001**  
14 cm, 5 1/2"

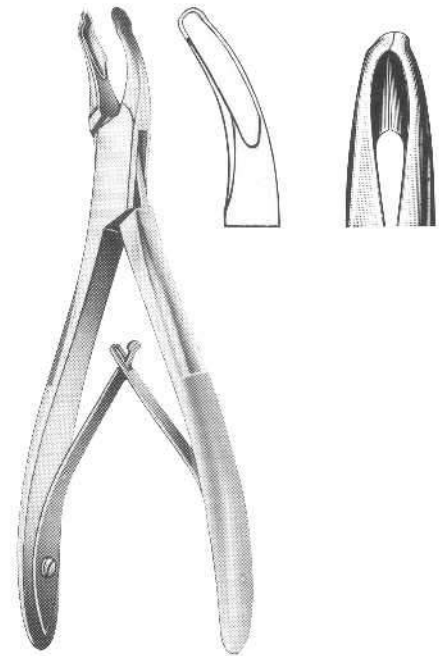

**LE-3002**  
Mead  
14 cm, 5 1/2"

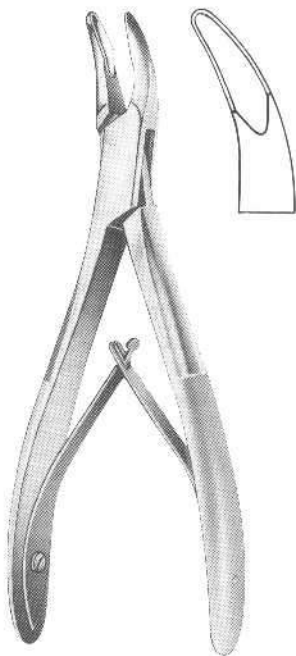

**LE-3003**  
Mead  
14 cm, 5 1/2"

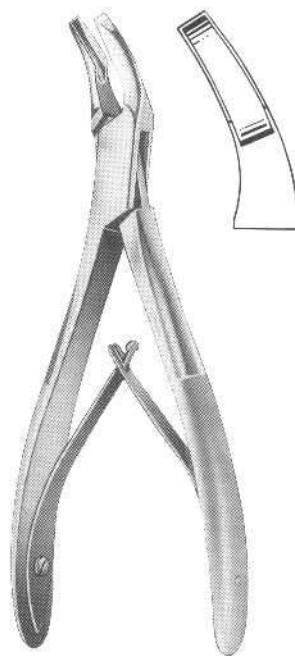

**LE-3004**  
Mead  
17 cm, 6 3/4"

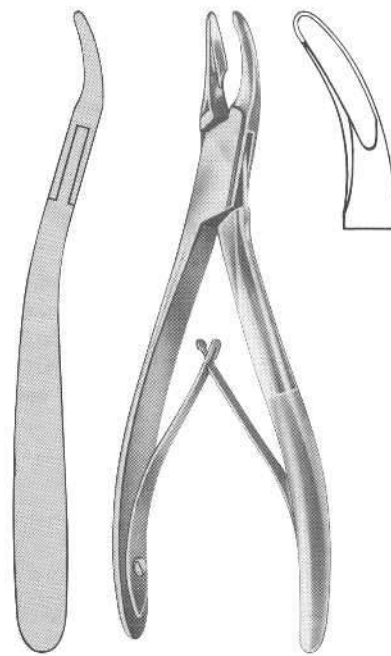

**LE-3005**  
Schell  
17 cm, 6 3/4"



**LE-3006**  
Luer  
15 cm



**LE-3007**  
Friedman  
14 cm



**LE-3008**  
Mini Friedman  
12 cm



**LE-3009**  
Goldman-Fax  
10 cm



**LE-3010**  
Blumenthal  
15 cm



**LE-3011**  
Blumenthal 45  
14,5 cm



**LE-3012**  
Blumenthal 90  
14 cm



**LE-3013**  
Bohler  
15 cm



**LE-3014**  
Kerrison  
15 cm



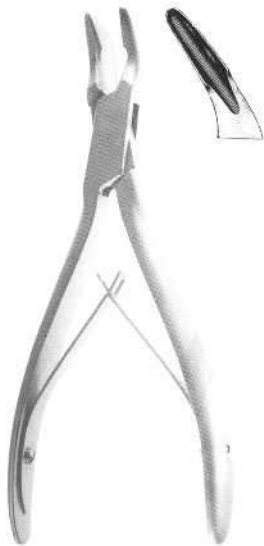

**LE-3015**  
Blumenthal  
16 cm, 6 1/4"



**LE-3016**  
Blumenthal  
16 cm, 6 1/4"

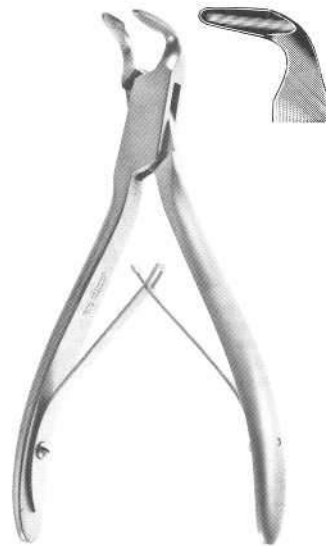

**LE-3017**  
Blumenthal  
16 cm, 6 1/4"

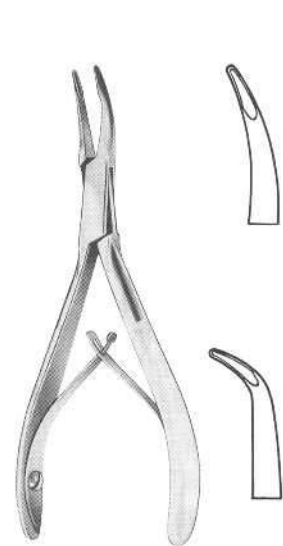

**LE-3018**  
Kleinert-Kutz  
14 cm, 5 1/2"



**LE-3019**  
Ruskin-Mini  
15 cm



**LE-3020**  
Beyr  
18 cm, 7 1/8"



**LE-3021**  
Zaufal-Jansen  
18 cm, 7 1/8"

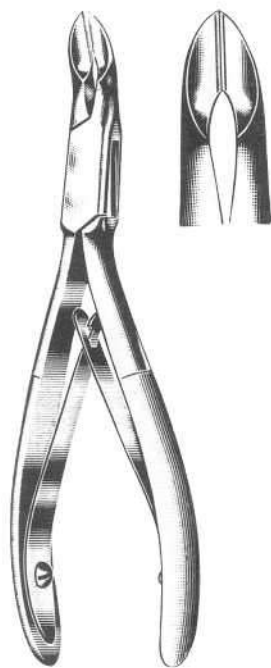

**LE-3022**  
Niro  
No. 5 S, 14 cm, 5 1/2"



**LE-3023**  
Cleveland  
No. 5 S, 17 cm, 6 3/4"

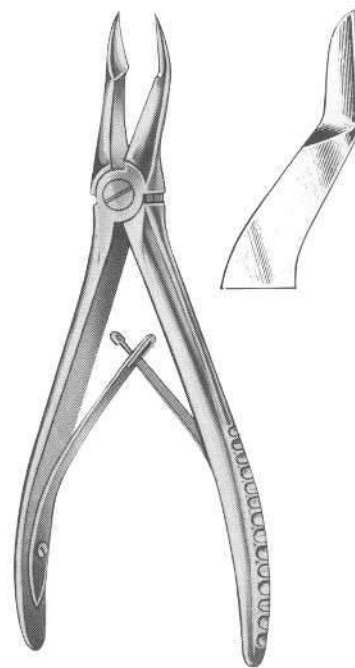

**LE-3024**  
No. 18, 15 cm, 6"

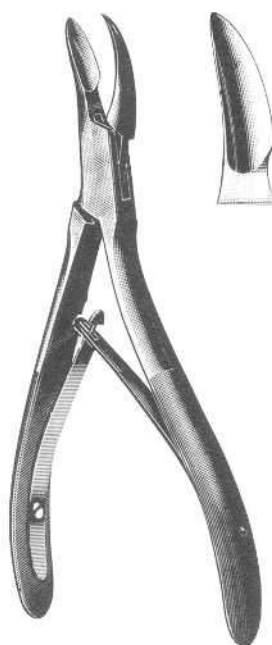

**LE-3025**  
Cleveland  
16 cm, 6 1/4"



**LE-3026**  
Gardner  
16 cm, 6 1/4"



**LE-3027**  
Liston-mini  
15 cm, 6"

# Bone Elevators

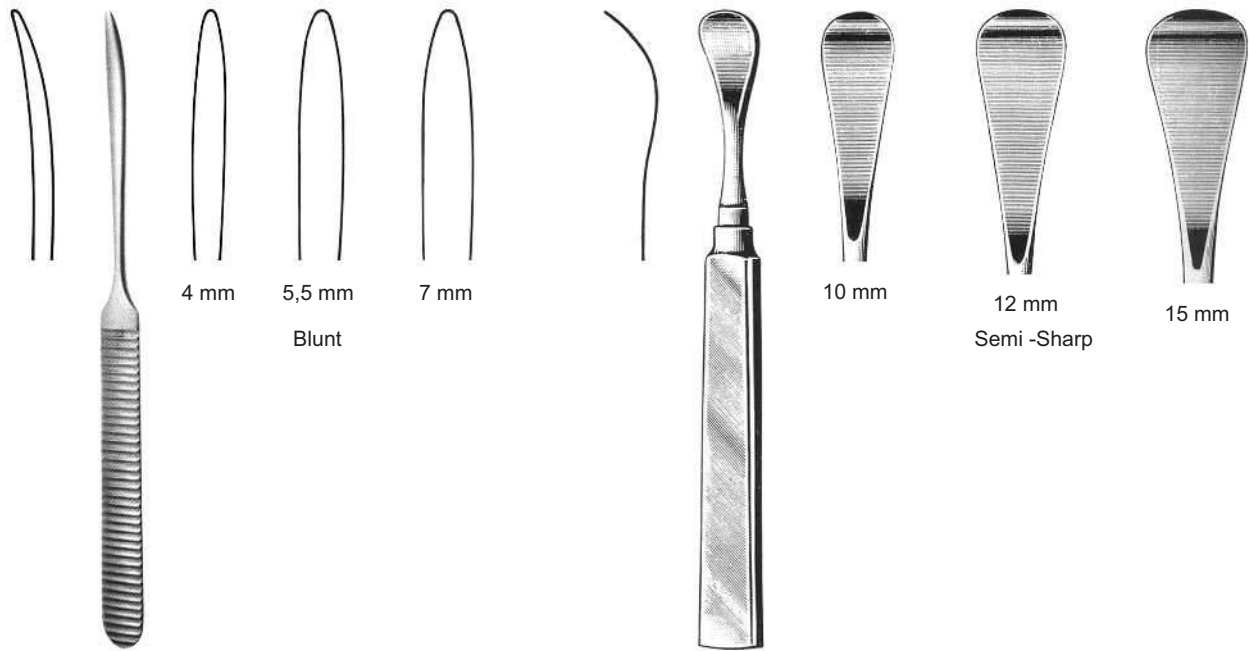

**LE-3100**  
Williger  
16 cm, 6 1/4"

**LE-3101**  
Henahan  
17 cm, 6 3/4"

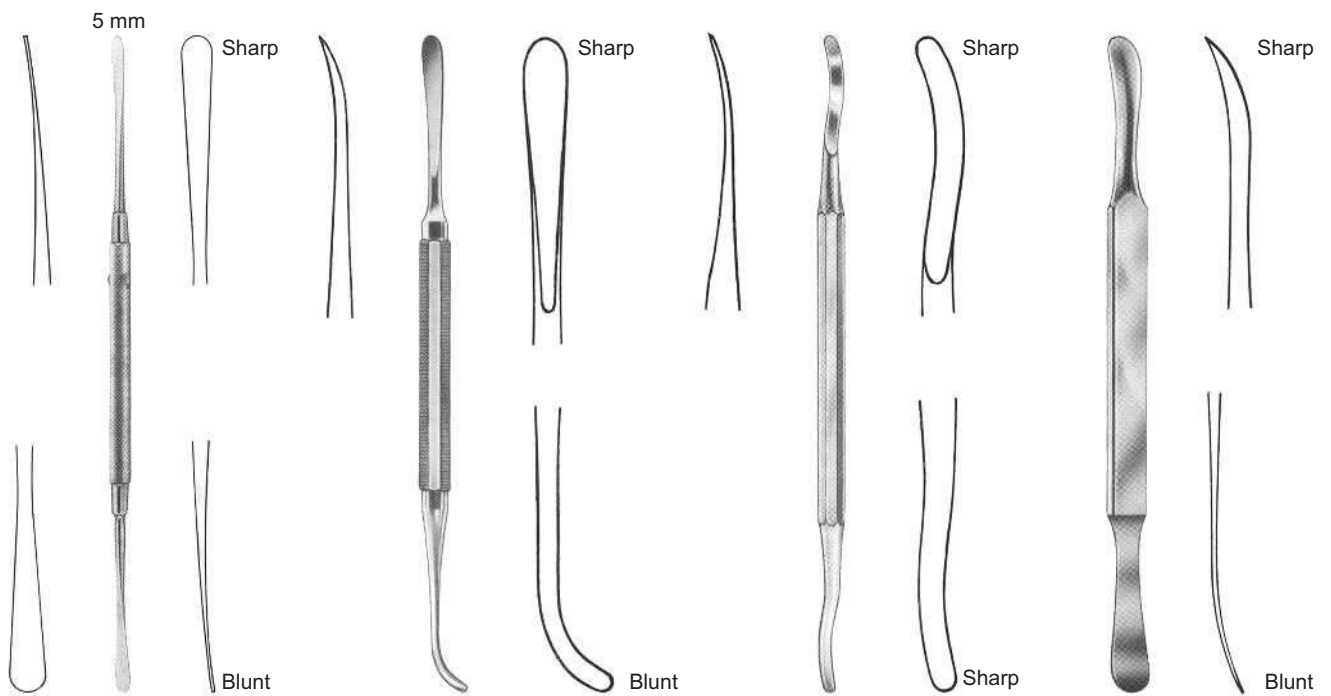

**LE-3102**  
Freer  
19 cm, 7 1/2"

**LE-3103**  
Bennet  
17 cm, 6 3/4"

**LE-3104**  
Seldin  
19 cm, 7 1/2"

**LE-3105**  
Seldin  
19,5 cm, 7 3/4"



**Buckley**  
15 cm, 6"



**LE-3106**  
No. 1  
3mm



**LE-3107**  
No. 2  
4mm



**LE-3108**  
No. 3  
5mm



**LE-3109**  
No. 4  
4mm



**LE-3110**  
No. 5  
4mm



**LE-3111**  
Killian  
16 cm, 6 1/4" 5 mm



**LE-3112**  
Killian-Claus  
16 cm, 6 1/4" 5 mm

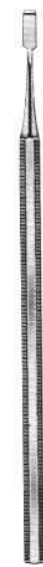

Obwegeser

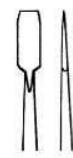

**LE-3113**  
2,5 mm

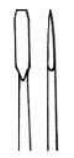

**LE-3114**  
4 mm



**LE-3115**  
Miller  
No.10C



**LE-3116**  
Miller  
No.11C



**LE-3117**  
Miller  
No.12C

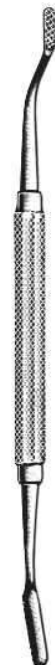

**LE-3118**  
Miller  
No.13C



Pinze per formare loops  
Loops forming pliers



**LE-3200**  
Adams  
Adams pliers for bending  
wires up to 0,7mm. (.28").



**LE-3201**  
Adams  
Adams pliers for bending  
wires up to 0,7mm. (.28").



**LE-3202**  
Adams  
Tweed loop forming pliers.  
For forming loop in wires up  
to 0,56 mm. (.22").



**LE-3203**  
Adams  
Aderer three jaws bending  
pliers. For wires up  
to 0,7 mm. (.28").



**LE-3204**  
Adams  
Aderer three jaws bending  
pliers. For wires upto 0,7 mm.  
(.28").

Ligature Cutter Pliers



**LE-3205**

Micro-miniature light wire cutter. It cuts soft ligature wires. For use in caso of limited access. Caution: maximum cutting capacity: soft ligature wire up to 0,30 mm. (.012").



**LE-3206**

Wire cutter. For ligature wires and pins. It is strong enough to bend archwire ends after distal cutting. Maximum cutting capacity up to 0,56 x 0,7 mm. (.022" x .028").

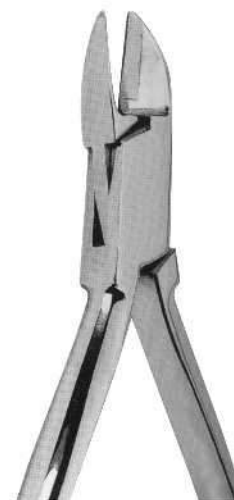

**LE-3207**

Wire cutter. For ligature wires and pins. It is strong enough to bend archwire ends after distal cutting. Maximum cutting capacity: up to 0,9 mm. (.036").

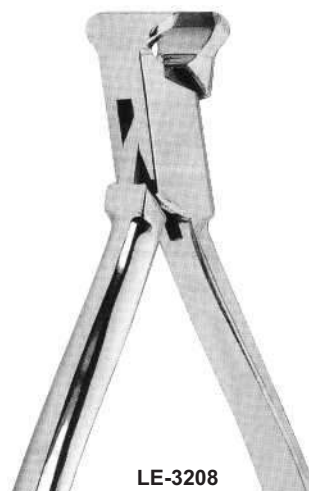

**LE-3208**

Wire cutter. For ligature wires and pins. It is strong enough to bend archwire ends after distal cutting. Maximum cutting capacity: up to 1,5 mm. (.044").

Pinze per formare laboratorio  
Laboratory pliers



**LE-3209**

Flat nose pliers with smooth beaks for bending wires up to 0,7 mm. (.028").



**LE-3210**

Bending wires up to 0,7 mm. (.028").



**LE-3211**

Bending wires up to 0,7 mm. (.028").



**LE-3212**

Bending wires up to 0,7 mm. (.028").



**LE-3213**  
Nance

Nance loop closing pliers, for bending of stop loops and special for Adams' clasps. Wires up to 0,7 mm. (.028").



**LE-3214**  
Nance

Universal pliers for bending wires up to 0,9 mm. (.035") or cutting up to 0,7 mm. (.028").

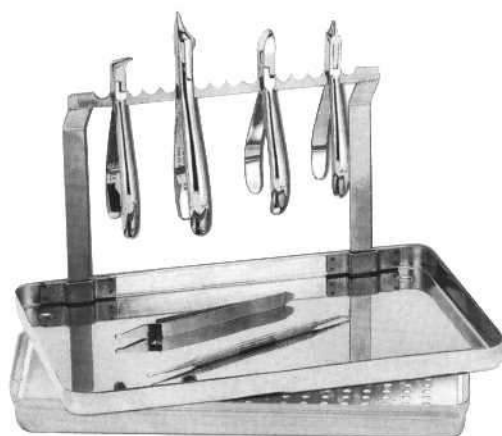

**LE-3215**

Stainless steel pliers tray standard dimensions



**LE-3216**  
Universal

Universal pin roughening, cutting and bending pliers. For wires up to 0,9 mm. (.035"). Will cut wires up to 0,7 mm. (.028").



## Utility and specialty pliers



**LE-3217**  
Reynolds

Reynolds contouring pliers.



**LE-3218**  
Reynolds

Lingual arch pliers used to form double and triple back bends in 0,7 mm (.028") or 0,9 mm (.035") wire for insertion in lingual sheaths.



**LE-3219**  
Weingart

Weingart pliers with serrated points.



**LE-3220**  
De La Rosa

De La Rosa arch forming pliers. Designed to form and contour arch wires on round or rectangular wire. The beak has grooves of 0,4 mm (.016"), 0,46 mm (.018") and 0,56 mm (.022").



**LE-3221**  
De La Rosa

Arch forming pliers with a non grooved contouring surface the forming of precise arches.

**Loop formare pliers**



**LE-3222**  
Waldsachs

Waldsachs universal pliers for bending wires up to 1,0 mm. (.039") or cutting up to 0,7 mm. (.028").



**LE-3223**

Round and Concave pliers for loop forming and bending of thin round and square wires up to 0,5 mm. (.020").



**LE-3224**  
Tweed

Tweed loop Forming Pliers. For round or rectangular wires up to 0,56 x 0,7 mm. (.022" x .028"). Replaceable cylindrical beak with three sizes: 1,15 mm. (.045), 1,50 mm. (.059"), 1,90 mm. (.075"). Concave beak with slight parallel serrations, to keep the wire in proper position.



**LE-3225**  
Tweed

Tweed Loop Forming Pliers. For making perfect Omega Loops with round or rectangular wires up to 0,56 x 0,7 mm. (.022" x .028"). The concave beak is exactly the same as pliers 5809-1



**LE-3226**  
Tweed

Single diameter loop forming pliers. Wire up to 0,56 x 0,7 mm. (.022" x 0,28"). Replaceable concave beak has only one diameter section of 1,50 mm. (.059").

## Distal end cutters



**LE-3227**

Distal end cutter -safety hold- a precision cutter designed for distal arch cutting in the patient's mouth. It cuts hard wires end holds the loose distal end preventing any damaging of oral tissue. Maximum cutting capacity rectangular wires up to 0,56 x 0,7 mm. (.022" x .020").



**LE-3228**

Micro- distal end cutter - safety hold-. Similar to 3227

## D.B. bracket remover pliers



**LE-3229**

Direct bonding bracket remover (wide). The removal grip firmly for easy incisal-gingival (vertical) use or, if needed, for mesial-distal (horizontal) use with the same ease.

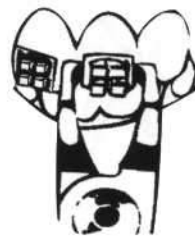

**LE-3230**

Direct bond attachment remover (angled). For removing all bonded attachments. May be used mesial-distal-horizontal) or incisal-gingival (vertical) in anterior areas. Angled perfectly for easy access to difficult posterior areas.

**Bird beak pliers**



**LE-3231**

Wire bending pliers. For wires up to 0,9 mm. (.036").

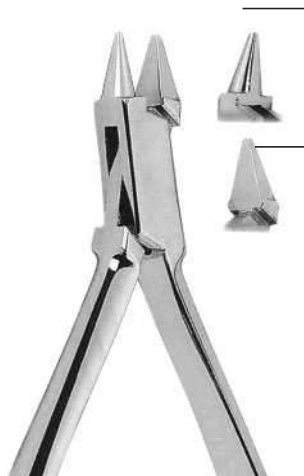

**LE-3232**

Bird Beak Angle pliers for bending round, square or rectangular wire up to 0,7 mm. (.028").



**LE-3233**

Double rounded jaw wire bending pliers. For wires up to 0,7 mm. (.028").



**LE-3234**

Bird beak pliers for bending round, square or rectangular wire up to 0,7 mm. (.028"). With cutter.

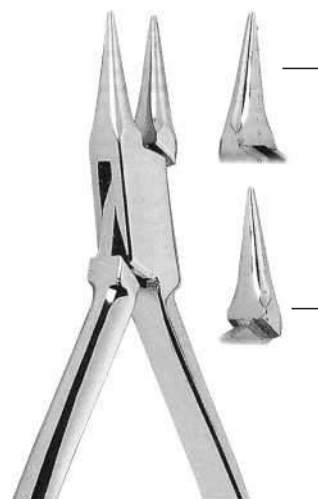

**LE-3235**

Double rounded jaw wire bending pliers. For wires up to 0,7 mm. (.028").



LE-4201  
Adam Plier TC



LE-4202  
Adam TC 12.5cm



LE-4203  
Tweed Arch 12.5cm



LE-4204  
HOW Plier Lingual TC



LE-4205

Weingart Plier TC



LE-4206  
 Weingart Plier Lingual TC



LE-4207  
 Weingart Slim Plier



LE-4208  
 Bird Beak Plier TC 13cm



LE-4209  
 Hardwire Cutter TC 15°



LE-4210  
 Distal Flush Cutter TC



**LE-4211**  
**Crimping Plier TC**



**LE-4212**  
**Clench Plier, Torquing Plier Set of 2 Male Female**



**LE-4213**  
**Hammer Head Plier**



**LE-4214**  
**Arch Plier**



**LE-4215**  
**Nance Loop Plier**



LE-4216  
Light Wire Plier



LE-4217  
Kim Pince TC 13cm



LE-4218  
Nance Loop Lingual TC Plier.





**LE-4301**  
**Band Remover Long Posterior Plier**



**LE-4302**  
**Band Remover Short Posterior Plier**



**LE-4303**  
**Band Remover Lingual TC Plier**



LE-4304  
Bracket Remover Lingual TC



LE-4305  
Bracket Remover Plier



LE-4306  
Bracket Remover Curved TC



LE-4307  
Bracket Remover Straight TC

0.50mm



1.00mm



LE-8801



LE-8802

0.75mm



LE-8803



LE-6101  
0.50mm



LE-6102  
0.75mm



LE-6103  
Regular



**LE-4401**  
**band Setter scaler**



**LE-4402**  
**Positive Positioner**



**LE-4403**  
**Red Bite Stick**



**LE-4404**  
**band pusher scaler**



LE-4501  
Ligature Director #3



LE-4502  
Ligature Director Twirl



LE-4503  
Gingrass Ligature Director



LE-4504  
Ligature Director Hollow



LE-4505  
Ligature Director T Tucker



LE-4506  
Ligature Director Tucker



LE-4601  
Mathieu Slim Line



LE-4602  
Elastic Ligature Mathieu Hole



14cm



LE-4603  
Ligature Mathieu Smaha



**LE-4701**  
**Bracket Placing Tweezers**



**LE-4702**  
**Reverse Action Tweezers**



**LE-4703**  
**Bracket Holding Tweezers**





LE-4801  
Bone Spreader Chisels Set of 4



LE-4802  
Soft Brushing Implantate Kit



LE-4803  
PRF Kit Set of 4 Titanium Color Coated



LE-4804  
Osteotome Curved Set of 5

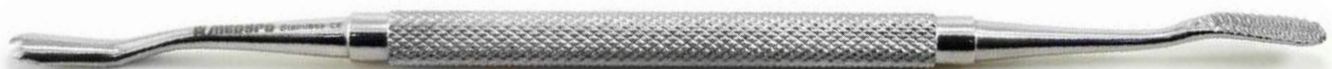

LE-4805  
Bone Scrapper Hollow Handle



LE-4806  
Bone Graft Syringe



LE-4807  
Bone Scraper Straight



LE-4808  
Bone File



LE-4809  
Bone Expansion Chisels Set of 4



LE-4810  
Bone Scraper Curved .



LE-4811  
Mallet Hammer



LE-4812  
Bone Spoon Graft Packer 4mm



**LE-4813**  
**Bone Compactor**



**LE-4814**  
**PRF BOX**



**LE-4815**  
**Palti Bone**



**LE-4816**  
**Bone Crush Mill**



**LE-4817**  
**Osteotome Straight Set of 5**



**LE-4818**  
**Bone Collector Filter 9mm**



LE-4901  
Crown Remover Pliers Compactor



LE-4902  
Crown Remover Turkish

# Pliers For Orthodontics and Prosthetics



**LE-3236**  
USA Model  
125 mm



**LE-3237**  
Waldron  
125 mm

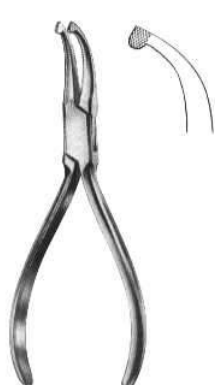

**LE-3238**  
How  
140 mm



**LE-3239**  
How  
145 mm



**LE-3240**  
Adams  
125 mm



**LE-3241**  
Angle  
125 mm



**LE-3242**  
young  
130 mm

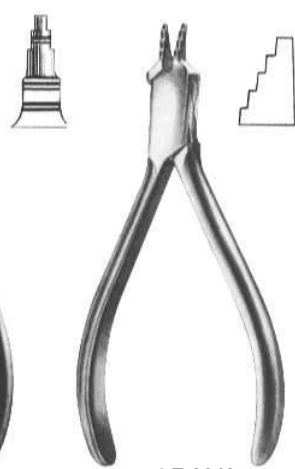

**LE-3243**  
Nance  
130 mm



**LE-3244**  
Weingart  
140 mm



**LE-3245**  
Johnson  
130 mm



**LE-3246**  
Mc Kellops  
155 mm



**LE-3247**  
Universal  
150 mm



**LE-3248**  
Waldsachs  
155 mm

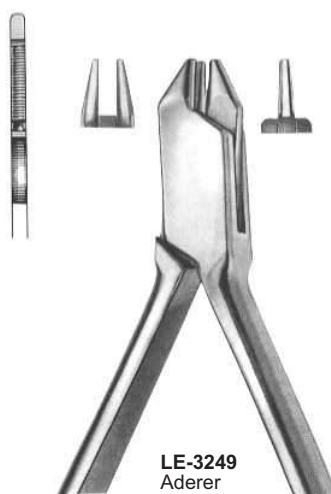

**LE-3249**  
Aderer  
125 mm



**LE-3250**  
Nance  
130 mm



**LE-3251**  
Langenbeck  
140 mm



**LE-3252**  
Langenbeck  
130 mm



**LE-3253**  
Langenbeck  
130 mm



**LE-3254**  
Peeso  
125 mm



**LE-3255**  
Goslee  
125 mm

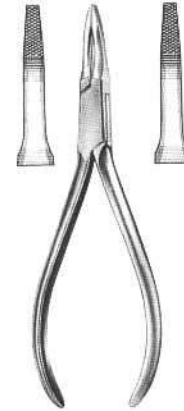

**LE-3256**  
Fischer  
140 mm

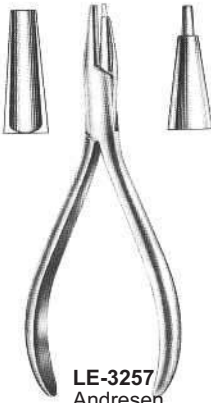

**LE-3257**  
Andresen  
130 mm

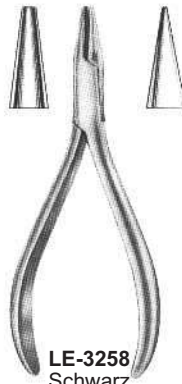

**LE-3258**  
Schwarz  
130 mm

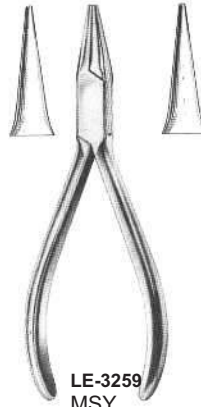

**LE-3259**  
MSY  
130 mm

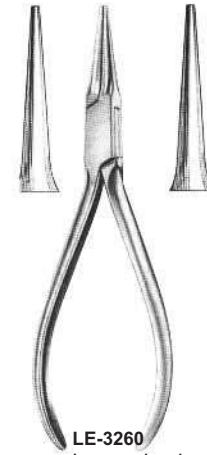

**LE-3260**  
Langenbeck  
125 mm



**LE-3262**



**LE-3263**



**LE-3264**



**LE-3265**



**LE-3266**



**LE-3267**



**LE-3268**

# Pliers For Orthodontics and Prosthetics



LE-3269



LE-3270

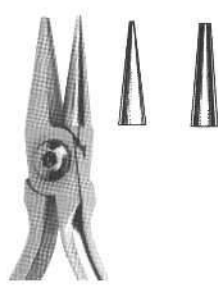

LE-3271

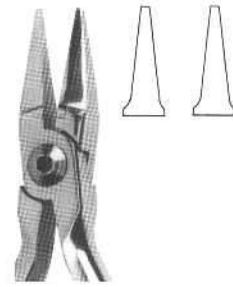

LE-3272

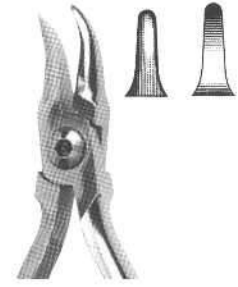

LE-3273



LE-3274



LE-3275



LE-3276



LE-3277



LE-3278



LE-3279

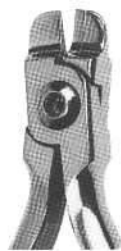

LE-3280



LE-3281



LE-3282

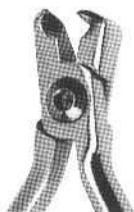

LE-3283



LE-3284



LE-3285



LE-3286

All Impression Trays Upper & Lower Type  
are available in S, M, L & XL Sizes



**LE-3300**  
"HYDRO-LOCK"  
stainless steel  
water-cooled  
impression trays  
with retention rim.



**LE-3301**  
"HYDRO-LOCK"  
stainless steel  
water-cooled impression  
trays with retention rim.



**LE-3302**  
"NEW SUPER"  
stainless steel  
impression trays  
with retention rim.



**LE-3303**  
"NEW SUPER" stainless  
steel impression trays  
with retention rim.



**LE-3304**  
"ANATOMIC" solid  
regular stainless  
steel impression  
trays without  
retention rim.



**LE-3305**  
"ANATOMIC" solid regular  
stainless steel impression  
trays without retention rim.



**LE-3306**  
Perforated-total denture  
stainless steel  
impression trays with rim.



**LE-3307**  
Perforated-total denture  
stainless steel  
impression trays with rim.



All Impression Trays Upper & Lower Type are available in S, M, L & XL Sizes



**LE-3308**  
"PERMA-LOCK" solid regular stainless steel impression trays with retention rim.



**LE-3309**  
"PERMA-LOCK" solid regular stainless steel impression trays with retention rim.



**LE-3310**



**LE-3311**



**LE-3312**



**LE-3313**



**LE-3314**



**LE-3315**



**LE-3316**  
Set of six

### PACKINGS



**3317**  
Set of Eight



**LE-3318**  
Solid stainless steel anterior depressed impression trays with retention rim.



**LE-3319**



**LE-3320**



**LE-3321**



**LE-3322**



**LE-3323**



**LE-3324**



**LE-3325**  
Solid stainless steel anterior depressed impression trays with retention rim.

All Impression Trays Upper & Lower Type  
are available in S, M, L & XL Sizes



**LE-3326**  
Fig. 0 per bambini - for children



**LE-3327**  
For narrow toothed upper jaws



**LE-3328**  
Fig. 0 per bambini - for children



**LE-3329**  
For partially toothed upper jaws



**LE-3330**  
For partially toothed lower jaws



**LE-3331**  
For edentulous upper jaws



**LE-3332**  
For edentulous lower jaws

All Impression Trays Upper & Lower Type are available in S, M, L & XL Sizes



**LE-3333**  
Solid total denture stainless steel impression tray with rim.



**LE-3334**  
Solid total denture stainless steel impression tray with rim.



**LE-3335**  
"PERMA-LOCK" perforated regular stainless steel impression trays with retention rim.



**LE-3336**  
"PERMA-LOCK" perforated regular stainless steel impression trays with retention rim.



**LE-3337**  
Perforated stainless steel anterior depressed impression trays with retention rim.



**LE-3338**



**LE-3339**



**LE-3340**



**LE-3341**



**LE-3342**



**LE-3343**

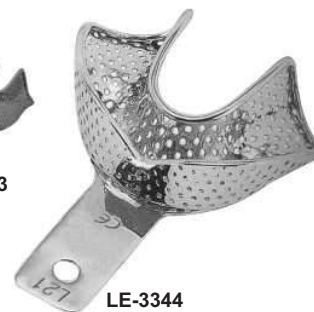

**LE-3344**  
Perforated stainless steel anterior depressed impression trays with retention rim.



**LE-3345**  
Perforated stainless steel impression trays without retention rim for complete denture.



**LE-3346**  
Perforated stainless steel impression trays without retention rim for complete denture.



LE-3400



3401



LE-3402



LE-3403



LE-3404





LE-3406



LE-3407



LE-3408



LE-3409



**LE-3500**  
**ENDODONTIC BOX**



**LE-3501**  
**STERILIZING BOX**  
Available in dif. sizes  
17x17x3 cm  
20x10x4 cm  
25x12x6 cm  
30x14x6 cm



**LE-3502**  
**ENDO TRAY BOX**



**LE-3503**  
**COTTON DISPENSER**



**LE-3504**  
**ALCOHOL LAMP**

**Sterilizing Drums**



**LE-3505 Small**



**LE-3506 Medium**



**LE-3507 Large**

**Sterilizing Boxes**



LE-3508



LE-3509



LE-3510

**Sterilizing Boxes**



LE-3511



LE-3512



LE-3513



LE-3514



LE-3515



LE-3516

**FORCEP AND THERMOMETER JARS**

**COTTON DISPENSER**



LE-3517  
IRRIGATOR(Douch can)



LE-3518  
MEASURING JUG



LE-3519  
KIDNEY TRAY



LE-3520  
**FORCEP JAR**



LE-3521  
**GALLIPOT WITH & WITHOUT LID**



LE-3522  
**SPITTEN MUG**



LE-3523  
**SPIRIT LAMP**



LE-3524  
**Perforated Tray**



LE-3525  
**Perforated Base**



LE-3526  
**Solid Base**



LE-3527  
**Instruments Tray**



LE-3528  
**Instruments Tray**



LE-3529  
**Instruments Tray  
(Perforated)**



LE-3530  
**Instruments Tray Shallow  
(Mayo)**



LE-3531  
**Scalers Tray**



LE-3532  
**Cathetar Tray**



*Top Diameter: 5 cm  
Base Diameter: 3 cm  
Height: 5 cm*



**LE-5001  
Spirit Lamp**



**LE-5002  
Small Mixing Bowl**



*18.5cm*  
**LE-5003  
Silicon Mixing Bowl with Plastic Spoon**



**LE-5101  
Bandage Scissors**



**LE-5102  
Dressing scissors Large**



LE-5201  
Ear Cleaner



LE-5202  
Ear Loops Set of 4



LE-5301  
Pin Wheel



LE-5302  
Taylor Reflex Hammer



LE-5303  
Hammer Pin Brush



LE-5401  
Weider Retractor



LE-5402  
Potts Elevator Set of 3



LE-5403  
Minnesota Retractor



LE-5404  
FaraBeuf Twin Retractor (2)



LE-5405  
Vestibulum Retractor



LE-5406  
Austin Retractor



LE-5407  
Sternberg Retractor



LE-5408  
Cheek Retractor



LE-5409  
FaraBeuf Twin Retractor (1)

13mm



11mm



17mm



15mm



LE-5410  
Eye Lid Retractor Set of 4



LE-5501  
Small



LE-5502  
Medium



LE-5503  
Large



**LE-5601**  
**Mushroom Elevators Set of 5**



**LE-5602**  
**Periosteal Elevators Set of 7**



**LE-5603**  
**Sinus Lift Elevators Set of ( Hollow Handle )**



**LE-5604**  
**Implant Tunelling Set of 5 Titanium Color Coated**



**LE-5605**  
**Molt 9**





**LE-5606**  
**Prichard Elevator Silver**



**LE-5607**  
**Prichard Elevator Titanium Color Coated**



**LE-5608**  
**Sinus Lift Elevators Set of 9**



**LE-5609**  
**Sinus Lift Elevators Set of 5 ( Sinus Handle )**



**LE-5610**  
**Buser Periosteal Elevator**



LE-5611  
Periosteal Sinus Lift Elevators Titanium Coated Set of 10



**LE-5701**  
**7 Pieces**



**LE-5702**  
**10 Pieces**



**LE-5703**  
**5 Pieces**

Premium Quality Instruments of All Kind of Dental Instruments





 **LAHEEF**  
ENTERPRISES  
—TOOLS OF THE TRADE—

*Friendly Specialist*  
**SERVICE**



 +92 (347) 472 5325

 Small Industrial Estate, Shahab Pura Rd, Sialkot - 51310 Pakistan

 laheefenterprises@gmail.com  [www.laheefenterprises.com](http://www.laheefenterprises.com)